



Liebert®

GXT5™ UPS

208 V Input (L1, L2, N, G), 120/208 V Output

MV

Installer/User Guide

The information contained in this document is subject to change without notice and may not be suitable for all applications. While every precaution has been taken to ensure the accuracy and completeness of this document, Vertiv assumes no responsibility and disclaims all liability for damages resulting from use of this information or for any errors or omissions. Refer to other local practices or building codes as applicable for the correct methods, tools, and materials to be used in performing procedures not specifically described in this document.

The products covered by this instruction manual are manufactured and/or sold by Vertiv. This document is the property of Vertiv and contains confidential and proprietary information owned by Vertiv. Any copying, use or disclosure of it without the written permission of Vertiv is strictly prohibited.

Names of companies and products are trademarks or registered trademarks of the respective companies. Any questions regarding usage of trademark names should be directed to the original manufacturer.

Technical Support Site

If you encounter any installation or operational issues with your product, check the pertinent section of this manual to see if the issue can be resolved by following outlined procedures. Visit <https://www.vertiv.com/en-us/support/> for additional assistance.

Table of Contents

Chapter 1: GXT5 Description	3
1.1. UPS Features and Available Models.....	3
1.2. Front Panels.....	4
1.3. Rear Panels.....	5
1.4. Removable Power Distribution Box.....	8
1.5. Internal Battery Packs.....	11
1.6. Major Internal Components and Operating Principle.....	11
1.7. UPS States and Operating Modes.....	13
1.7.1. Normal Mode.....	13
1.7.2. Bypass Mode.....	13
1.7.3. Battery Mode.....	13
1.7.4. Frequency Converter Mode.....	14
1.7.5. ECO Mode.....	14
Chapter 2: Installation	15
2.1. Unpacking and Inspection.....	15
2.2. Pre-installation Preparation.....	15
2.2.1. Installation Clearances.....	15
2.3. Installing the UPS.....	16
2.3.1. Tower Installation.....	16
2.3.2. Rack Installation.....	17
2.4. Installing the Internal Battery Kit(s).....	17
2.5. Installing External Battery Cabinets.....	18

2.6. Installing a Power-output Distribution Box	21
2.6.1.Installing the Power Distribution Box on GXT5-5000MVRT4UXLN and GXT5-6000MVRT4UXLN Models.....	21
2.6.2.Installing the Power Distribution Box on GXT5-8000MVRT6UXLN and GXT5-10KMVRT6UXLN Models.....	21
2.7. Removing the Power Distribution Box from GXT5-5000MVRT4UXLN and GXT5-6000MVRT4UXLN Models.....	22
2.8. Removing the Power Distribution Box from GXT5-8000MVRT6UXLN and GXT5-10KMVRT6UXLN Models.....	23
2.9. Hardwired Input/Output Connections.....	24
2.9.1.Branch Circuit Breaker.....	25
2.9.2.Terminal-block Connections.....	26
2.10. Communication Connections.....	28
2.10.1.Connecting IntelliSlot Communication.....	28
2.10.2.Connecting to the Dry-contact Port.....	28
2.10.3.Connecting a Remote Emergency Power-off (REPO) Switch.....	30
2.10.4.Connecting a USB Cable.....	31
2.10.5.Connecting CLI Communication Cables.....	31
Chapter 3: Operating the UPS.....	33
3.1. Silencing the Audible Alarm.....	33
3.2. Starting-up the UPS.....	33
3.3. Transferring to Battery Mode.....	34
3.4. Transferring from Normal to Bypass Mode.....	34
3.5. Transferring from Bypass to Normal Mode.....	34
3.6. Shutting-down the UPS Completely.....	35
3.7. Remote Emergency Power-off (REPO).....	35

Chapter 4: Operation and Display Panel.....	37
4.1. LED Indicators.....	39
4.2. LCD Menu and Screens.....	39
4.2.1.Start-up and Flow Screens.....	39
4.2.2.Main Menu.....	40
4.2.3.Status Screen.....	41
4.2.4.Settings Submenu.....	44
4.2.5.Control Screen.....	52
4.2.6.Log Screen.....	53
4.2.7.About Screen.....	56
4.3. Editing Display and Operation Settings.....	58
4.3.1.Settings Prompts.....	59
4.3.2.Changing the Password.....	59
4.3.3.Selecting the Display Language.....	60
4.3.4.Setting the Date and Time.....	60
 Chapter 5: Maintenance	 61
5.1. Replacing Batteries.....	61
5.2. Charging Batteries.....	63
5.3. Checking UPS Operation.....	63
5.4. Cleaning the UPS.....	64
5.5. Replacing a POD	64
5.6. Firmware Updates.....	67
5.6.1.Updating Firmware with RDU101 Card Connection.....	67
5.7. Updating DSP Firmware via RDU101.....	69

Chapter 6: Troubleshooting	73
6.1. Symptoms that Require Troubleshooting.....	73
6.2. Audible Alarm (Buzzer).....	73
6.2.1.Faults.....	74
6.3. Troubleshooting UPS Issues	75
 Chapter 7: Specifications	 77
7.1. Battery Run Times	81
 Appendix I: Open Source Software Legal Notices	 85
 Appendix II: Technical Support	 87

Important Safety Information

IMPORTANT! This manual contains important safety instructions that must be followed during the installation and maintenance of the UPS and batteries. Read this manual thoroughly and the safety and regulatory information, available at <https://www.vertiv.com/ComplianceRegulatoryInfo>, before attempting to install, connect to supply, or operate this UPS.

This page is intentionally left blank.

Chapter 1: GXT5 Description

The Liebert® GXT5 is a compact, online uninterruptible power system (UPS) that continuously conditions and regulates its output voltage. The Liebert® GXT5 supplies microcomputers and other sensitive equipment with clean sine-wave input power.

Upon generation, AC power is clean and stable. However, during transmission and distribution it is subject to voltage sags, spikes, and complete failure that may interrupt computer operations, cause data loss, and damage equipment.

The Liebert® GXT5 protects equipment from these disturbances. The Liebert® GXT5 continuously charges its batteries from the mains, enabling it to supply power to connected loads, even when the mains fail.

1.1. UPS Features and Available Models

The GXT5 includes the following features. [Table 1-1](#) below, lists the available models and power ratings.

- Enhanced load capacity with an output power factor of 1.
- Input power factor greater than 0.99.
- Optional tower or rack installation to meet varying installation requirements.
- Adapts to areas with unstable power-mains supply via high-frequency double-conversion topology structure, with high input-power factor, wide input-voltage range, and output immune to grid interference.
- Operation and display panel with model-specific color LCD offers simple configuration and control of the UPS.
- ECO power-supply mode and smart-sleep mode help you save the maximum amount of energy.

Table 1-1 UPS Models and Power Ratings

MODEL NUMBER	NOMINAL POWER RATING @ 120/208 V
GXT5-5000MVRT4UXLN	5000 VA/5000 W, 120/208 Vac
GXT5-6000MVRT4UXLN	6000 VA/6000 W, 120/208 Vac
GXT5-8000MVRT6UXLN	8000 VA/8000 W, 120/208 Vac
GXT5-10KMVRT6UXLN	10000 VA/10000 W, 120/208 Vac
GXT5-15KMVRT11UXLN	15000 VA/15000 W, 120/208 Vac
GXT5-20KMVRT11UXLN	20000 VA/20000 W, 120/208 Vac

1.2. Front Panels

The various GXT5 models have the same general appearance, with the main difference being the receptacle types on the rear panel.

Figure 1-1 Front View

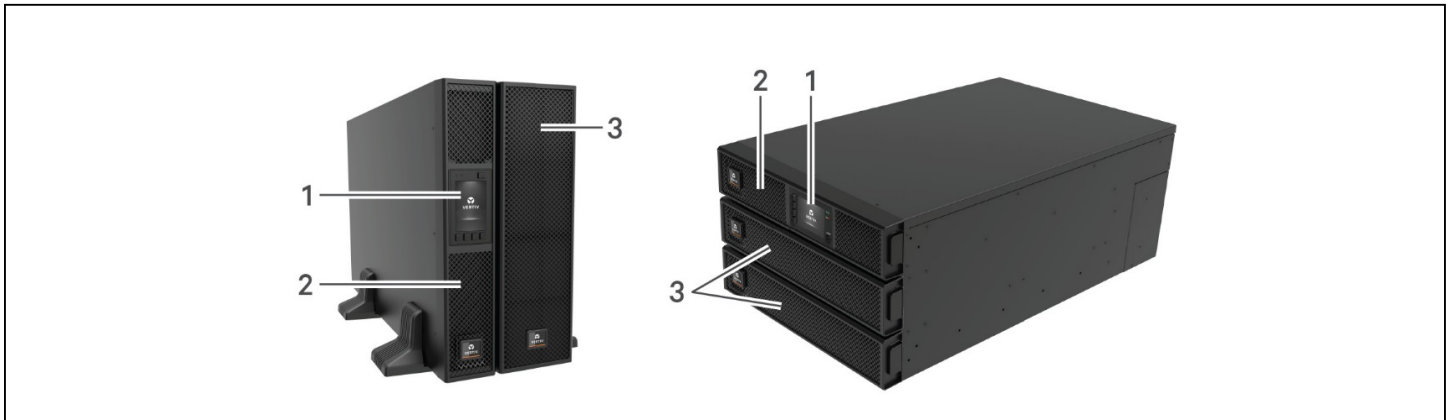

ITEM	DESCRIPTION
1	Operation/Display panel
2	Upper bezel
3	Lower bezel/battery-access door

1.3. Rear Panels

The following figures detail the rear-panel features for each GXT5 model.

Figure 1-2 GXT5-5000/6000MVRT4UXLN Rear Panel

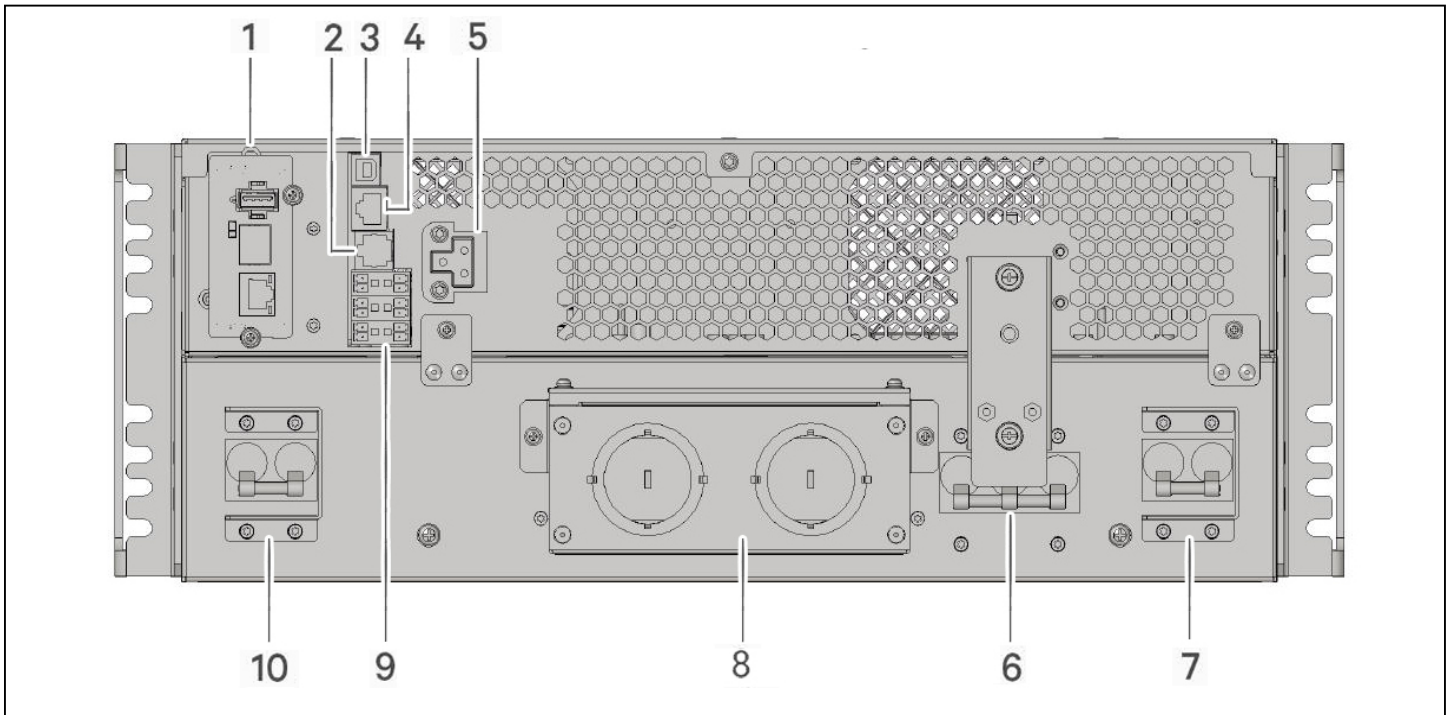

ITEM	DESCRIPTION
1	Liebert® IntelliSlot™ port
2	RS-232 port, RJ-45/RJ-11 connection -- Used for CLI
3	USB port
4	RS-485 port, RJ-45 connection -- Used for external temperature sensors
5	External-battery-cabinet connector
6	Maintenance-bypass breaker
7	Input breaker
8	Knockouts for hard-wired input and output
9	Terminal-block communication connectors
10	Output breaker

Figure 1-3 GXT5-8000/10KMVRT6UXLN Rear Panel

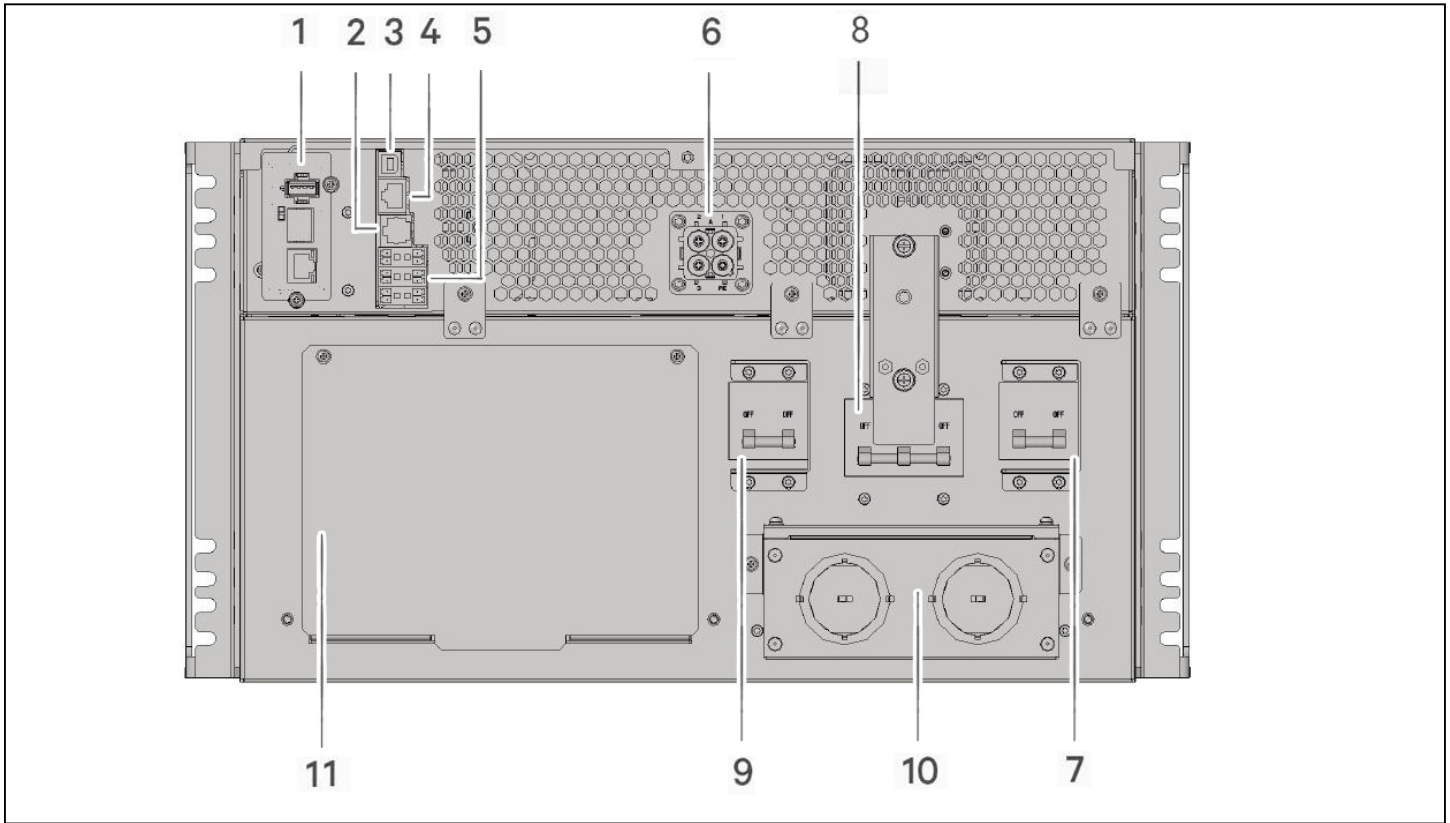

ITEM	DESCRIPTION
1	Liebert® IntelliSlot™ port
2	RS-232 port, RJ-45/RJ-11 connection -- Used for CLI
3	USB port
4	RS-485 port, RJ-45 connection -- Used for external temperature sensors
5	Terminal-block communication connectors
6	External-battery-cabinet connector
7	Output breaker
8	Maintenance-bypass breaker
9	Input breaker
10	Knockouts for hard-wired input and output
11	Cover for power-distribution box connector

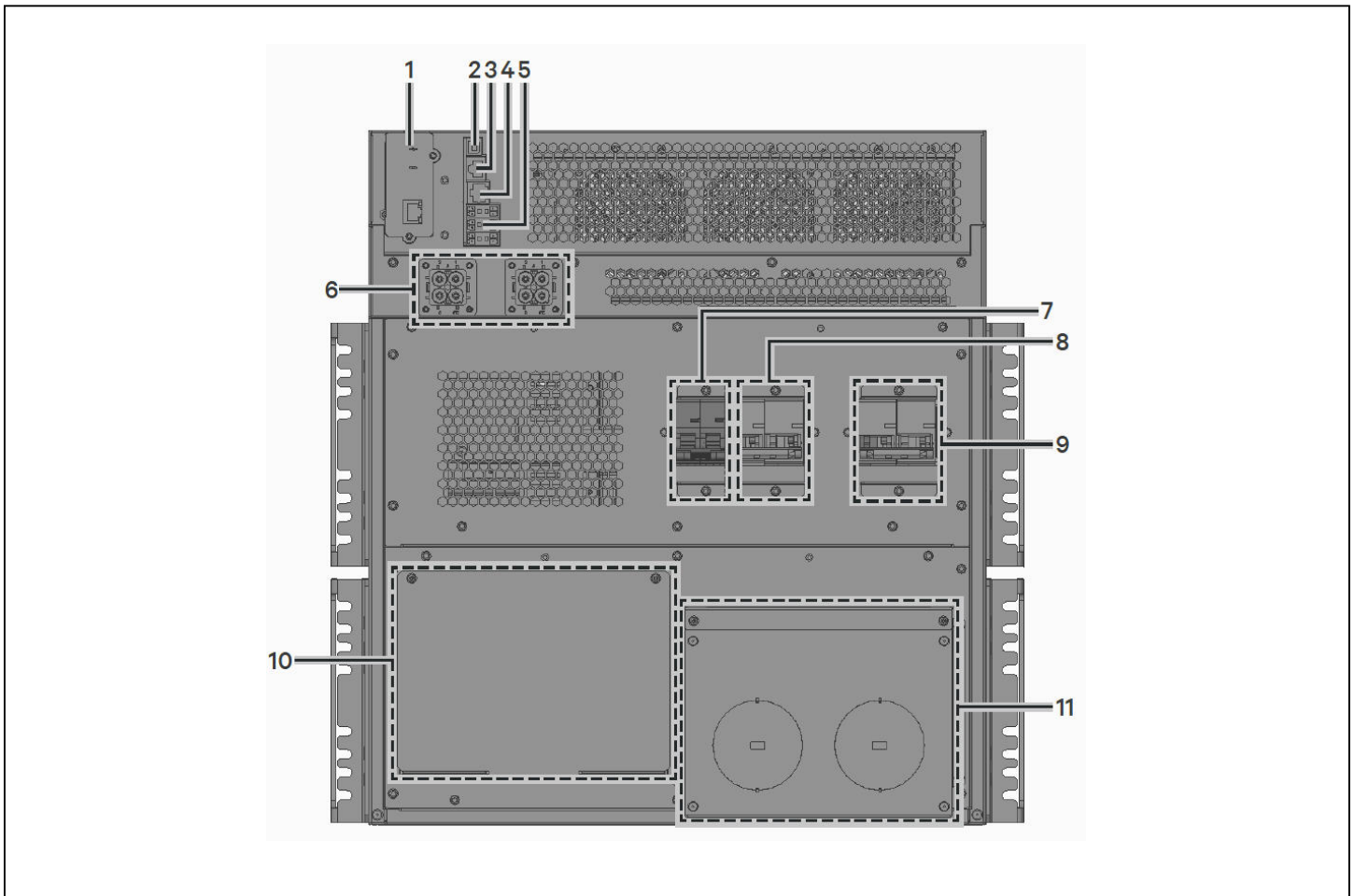
Figure 1-4 GXT5 UPS GXT5 15/20KMVRT11UXLN Rear Panel

ITEM	DESCRIPTION
1	Liebert® IntelliSlot™ port
2	USB port
3	RS-485 port -- Used for external temperature sensors
4	RS-232 port -- Used for CLI
5	Dry-contacts, Battery Detection (3), REPO input (REPO)
6	External-battery-cabinet connector
7	POD breaker
8	Output breaker
9	Input breaker
10	Cover for power-distribution box connector
11	Knockouts for hard-wired input and output

1.4. Removable Power Distribution Box

The 5-kVA and 6-kVA models ship with the PD5-UL6HDWR-MBS installed. This POD includes the input circuit breaker for the UPS, and the POD options are shown in [Figure 1-5](#) below.

The 8-kVA and 10-kVA models ship with the standard POD installed. The POD options are shown in [Figure 1-6](#) on [page 9](#), and [Figure 1-7](#) on [page 10](#).

NOTE: In [Figure 1-5](#) below, the components on PD5-001 are labeled. The features may be arranged differently on other PODs.

Figure 1-5 Power-output Distribution Options for GXT5 5000/6000MVRT4UXLN

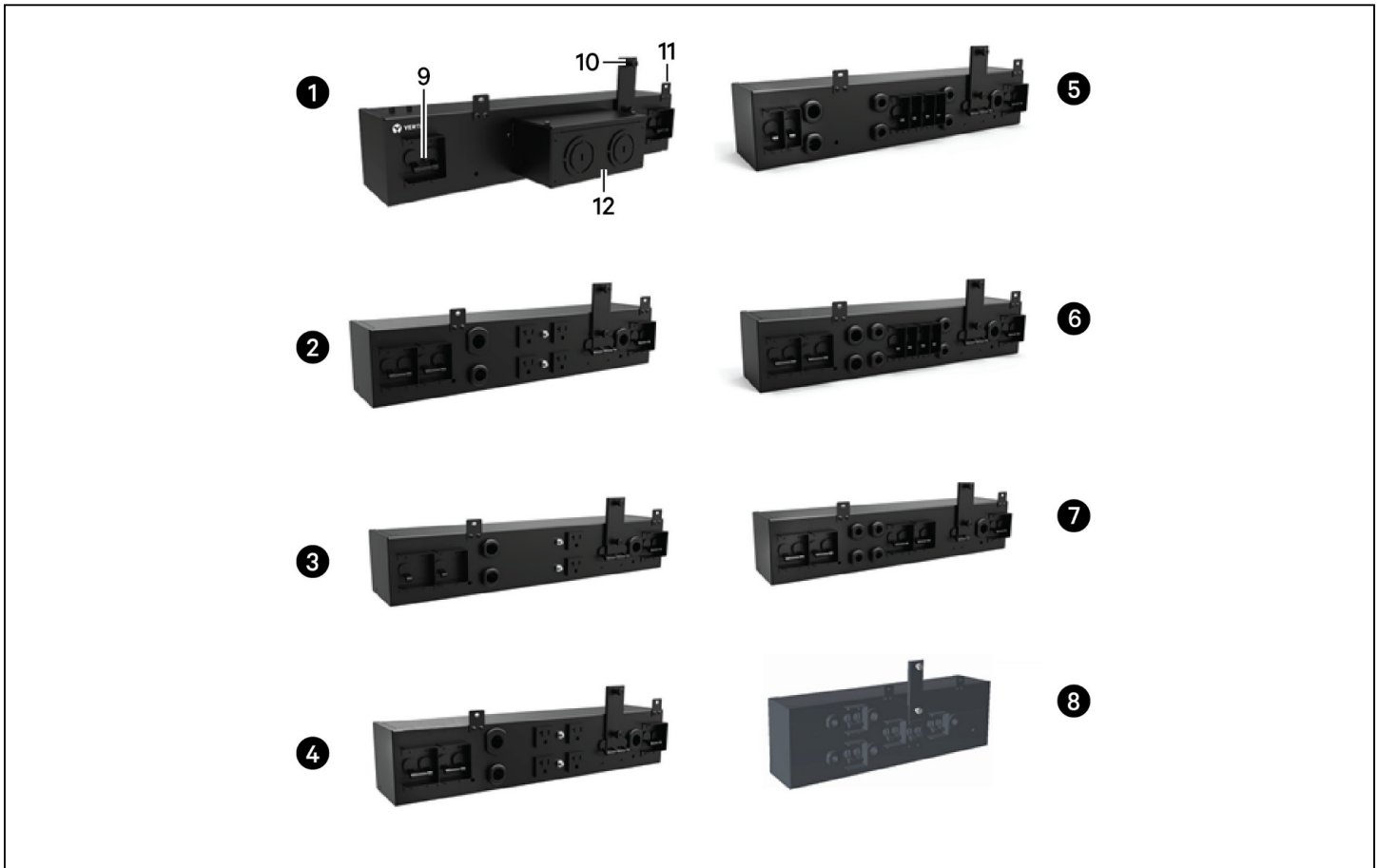

ITEM	PART NUMBER	INPUT CONNECTIONS	OUTPUT CONNECTIONS
1	PD5-UL6HDWR-MBS	Hardwire	Hardwire
2	PD5-001	L14-30P	1x L14-30R, 1x L6-30R, 4x 5-15/20 T slot
3	PD5-002	L14-30P	2x L6-20R, 2x 5-15/20R T slot
4	PD5-003	L14-30P	2x L6-30R, 4x 5-15/20R T slot
5	PD5-004	L14-30P	4x L5-20R, 2x L5-30R
6	PD5-005	L14-30P	4x L5-20R, 2x L6-30R
7	PD5-006	L14-30P	4x L6-20R

NOTE: In [Figure 1-6](#) below, the components on PD2-101 are labeled. The features are arranged differently on other PODs.

Figure 1-6 Several Power-output Distribution Options for GXT5-8000/10KMVRT6UXLN

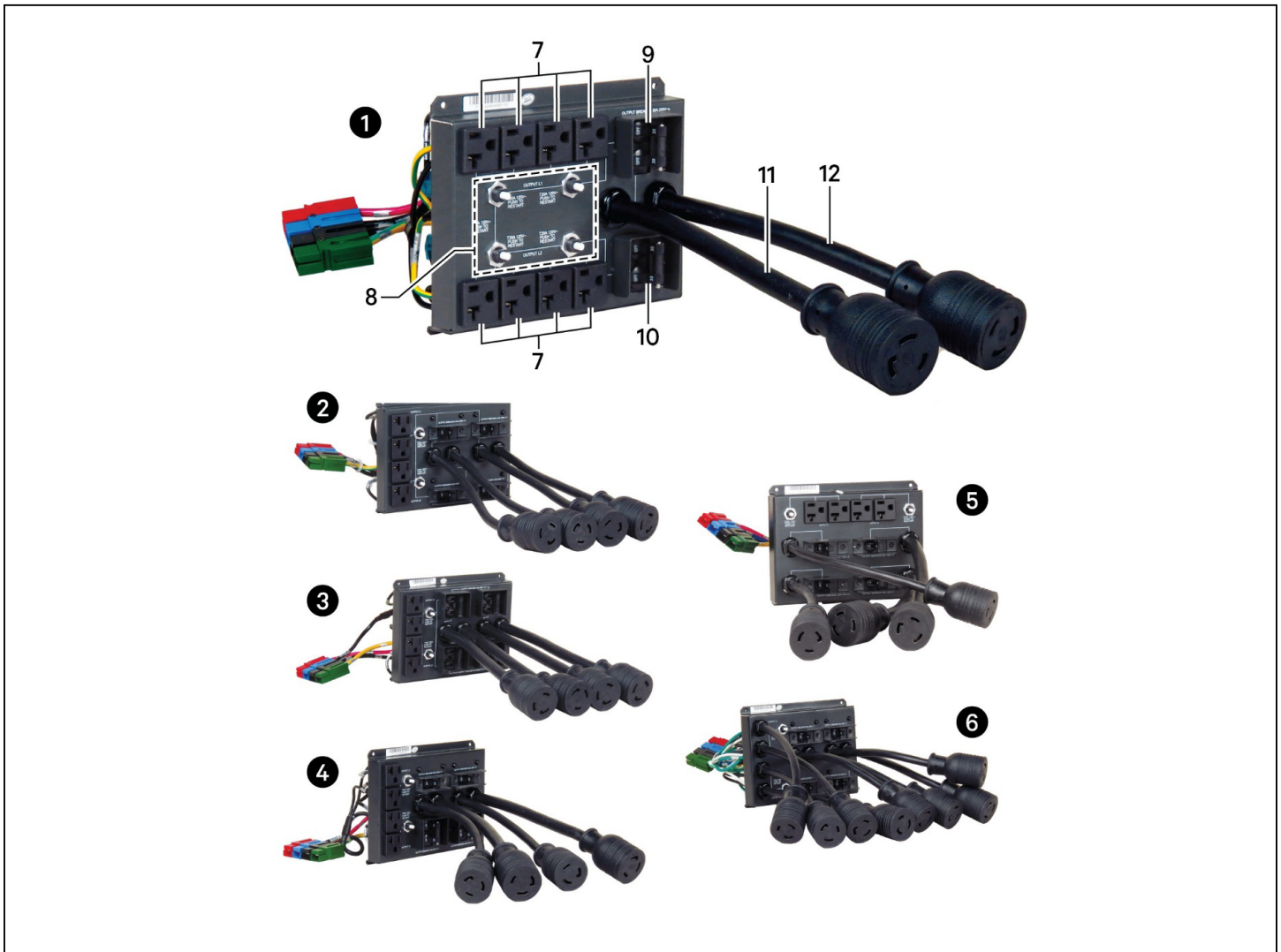

ITEM	PART NUMBER	OUTPUT CONNECTIONS
1	PD2-101	2x L6-30R, 8x 5-15/20R T slot
2	PD2-102	4x L6-20R, 4x 5-15/20R T slot
3	PD2-103	4x L6-30R, 4x 5-15/20R T slot
4	PD2-104	4x 5-15/20R T slot, 2x L6-30R, 2x L6-20R
5	PD2-105	4x 5-15/20R T slot, 2x L5-30R, 2x L5-20R
6	PD2-106	4x L6-20R, 4x L5-20R

Figure 1-7 Additional Power-output Distribution Options for GXT5-8000/10KMVRT6UXLN and GXT5-15K/20KMVR-T11UXLN

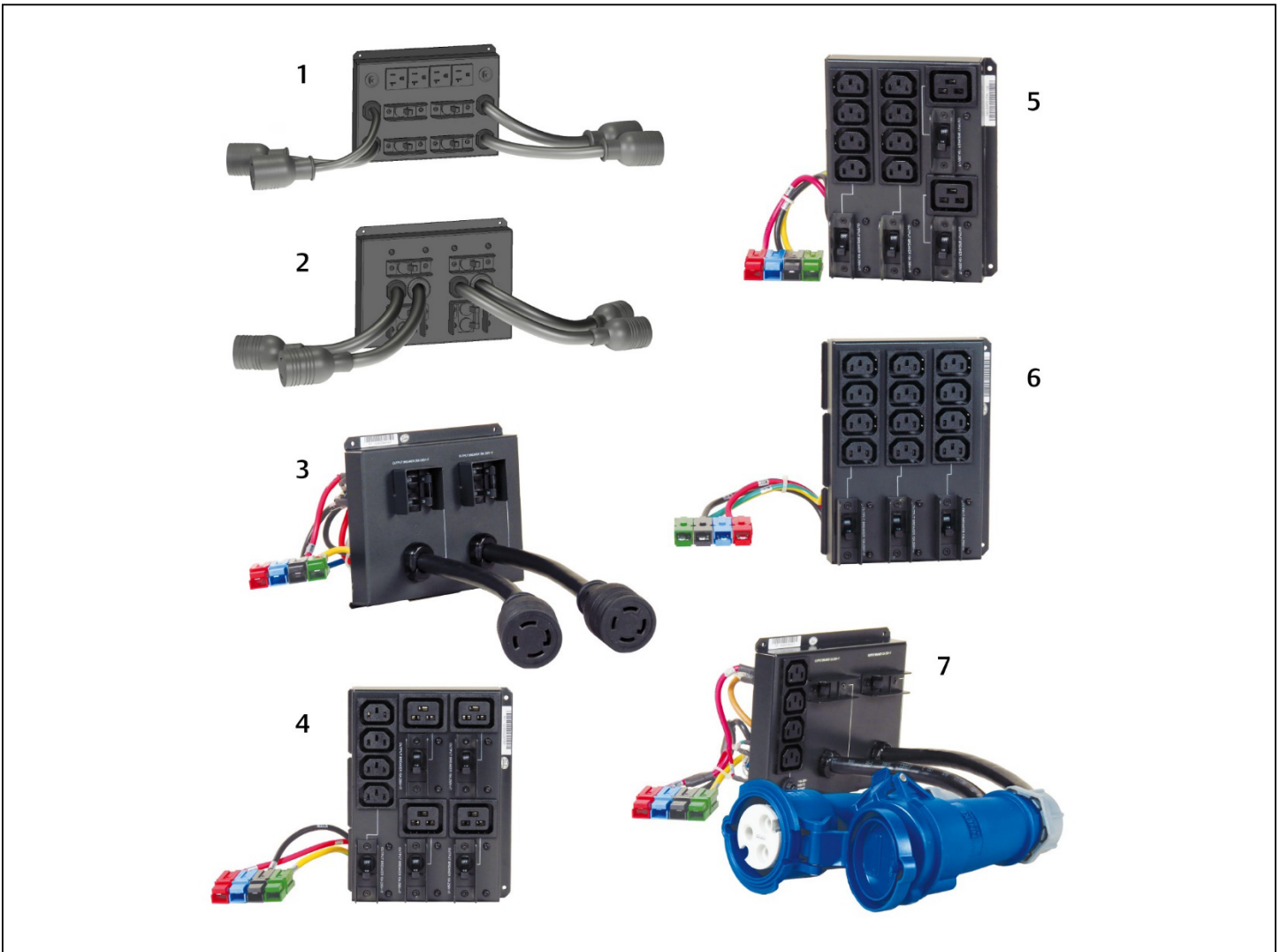

ITEM	PART NUMBER	OUTPUT CONNECTIONS
1	PD2-107	4x L5-20R, 4x 5-15/20R T slot
2	PD2-108	2x L6-30R, 2x L6-20R
3	PD2-109	2x L14-30R
4	PD2-200	4x IEC320-C19, 4x IEC320-C13
5	PD2-201	2x IEC320-C19, 8x IEC320-C13
6	PD2-202	12x IEC320-C13
7	PD2-204	2x IEC309-32A, 4x IEC320-C13

1.5. Internal Battery Packs

The internal battery packs for all GXT5 MV models, shown in [Figure 1-8](#) below, are located behind the access door on the front of the UPS. 5-kVA and 6-kVA units have 1 battery pack, and 8-kVA and 10-kVA units have 2 battery packs and 15-kVA and 20-kVA units have 4 battery packs.

Figure 1-8 Internal Battery Pack

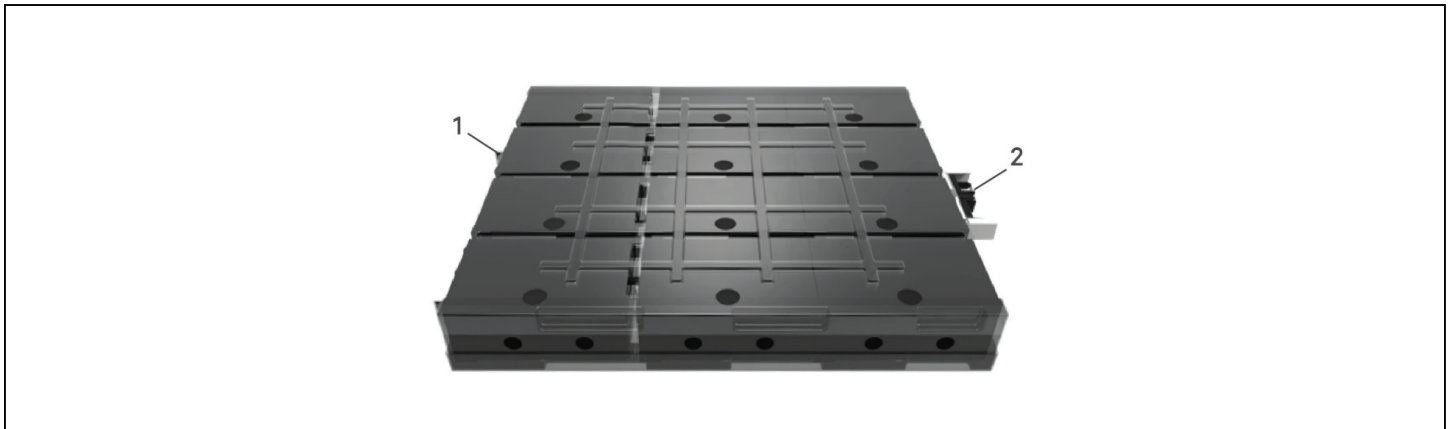

ITEM.	DESCRIPTION
1	Handle
2	Connector

1.6. Major Internal Components and Operating Principle

[Figure 1-9](#) on the next page, shows the UPS operating principle. [Table 1-2](#) on the next page, describes the function of the major components in the UPS.

NOTE: [Figure 1-9](#) on the next page, is one example of basic operation.

Figure 1-9 Basic Operating Principle Diagram

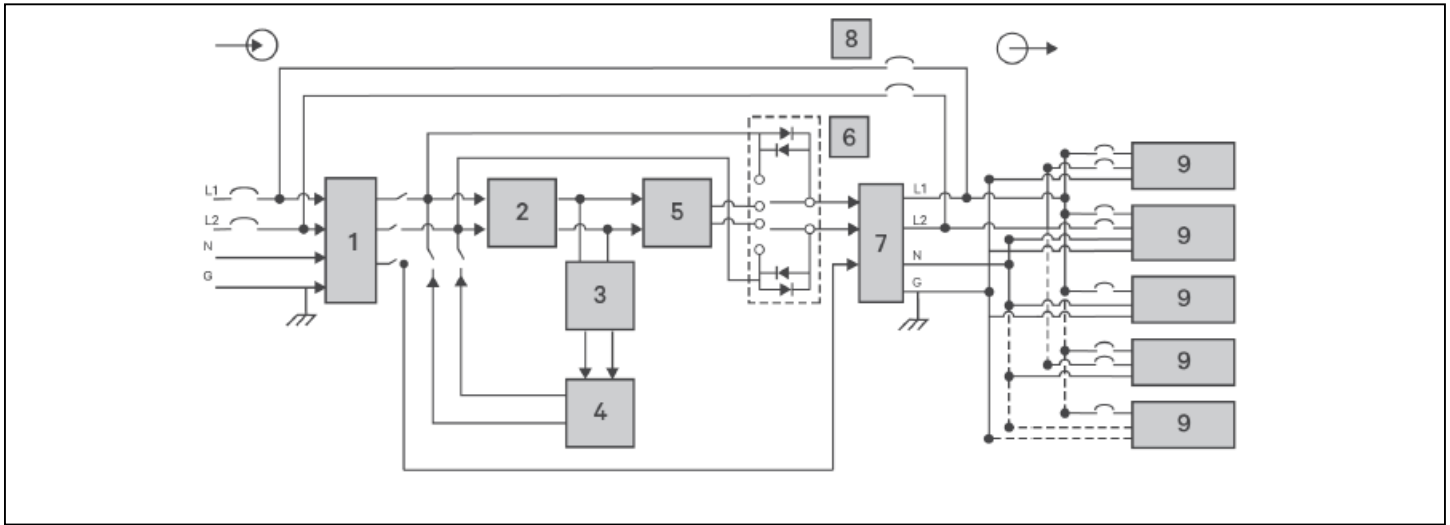

Table 1-2 Major Components

ITEM	COMPONENT	OPERATION/FUNCTION
1	Transient Voltage Surge Suppression (TVSS) and EMI/RFI Filters	Provide surge protection. Filter electromagnetic interference (EMI) and radio frequency interference (RFI). Minimize surges or interference present in the utility power and protect devices connected on the same branch as the UPS.
2	Rectifier/Power Factor Correction (PFC) Circuit	In normal operation, converts utility AC power to regulated DC power for use by the inverter while ensuring that the wave shape of the input current used by the UPS is near ideal. Extracting this sine-wave input current ensures efficient use of utility power and reduces reflected harmonic distortion making cleaner power available to devices that are not protected by the UPS. The DC-to-DC converter raises the DC voltage from the battery to the optimum operating voltage for the inverter. This allows the inverter to operate continuously at its optimum efficiency and voltage, thus increasing reliability.
3	Battery Charger	Regulates input AC power to continuously float-charge the batteries. Batteries are charged when the UPS is plugged in, even when not powered-on.
4	Batteries	Valve-regulated, non-spillable, lead-acid batteries. NOTE: To maintain battery design life, operate the UPS in an ambient temperature of 59 °F to 77 °F (15 °C to 25 °C).
5	Inverter	In normal operation, inverts the DC output of the PFC circuit into precise, regulated sine-wave AC power. When utility power fails, the inverter receives DC power from the DC-to-DC converter. In either operating mode, the UPS inverter remains on-line, generating clean, precise, regulated AC-output power.
6	Dynamic Internal Bypass	In the unlikely event of UPS failure such as overload or over-temperature, automatically transfers the connected load to bypass. To manually transfer the connected load from inverter to bypass, see "Transferring from Normal to Bypass Mode" on page 34.
7	EMI/RFI Filters	Filter electromagnetic interference (EMI) and radio frequency interference (RFI). Minimize interference present in the utility power and protect devices connected on the same branch as the UPS.
8	Maintenance Bypass	In the unlikely event of UPS failure, allows replacing the UPS while keeping the connected equipment powered with utility power. NOTE: The bypass power path does not protect connected equipment from disturbances in the utility supply. 15-kVA and 20-kVA units do not have internal maintenance bypass.
9	Outlet group	General output receptacles.

1.7. UPS States and Operating Modes

NOTE: See [LED Indicators](#) on [page 39](#), for description of the run-indicator and alarm-indicator LEDs mentioned in this section.

1.7.1. Normal Mode

When utility power is normal, Normal mode employs the rectifier and inverter to provide voltage and frequency-stabilized power to the load. The charger charges the battery in normal mode. On the front panel display, the run-indicator (green) is ON, the alarm indicator is OFF, and the buzzer is silent.

1.7.2. Bypass Mode

Bypass mode supplies power to the load from the bypass source (utility power) if an overload or fault occurs during normal operation. On the front-panel display, the run indicator (green) is ON, the alarm indicator (yellow) is ON, and the buzzer beeps once each seconds. The LCD “Current” screen displays “On Bypass.”

NOTE: If utility power fails or if the utility voltage goes outside of the permissible range during bypass-mode operation, the UPS shuts down and no output is supplied to the load.

1.7.3. Battery Mode

Battery mode supplies battery power to the load if utility power fails or if the utility voltage goes outside of the permissible range. On the front-panel display, the run indicator (green) is ON, the alarm indicator (yellow) is ON, and the buzzer beeps once each second. The LCD “Flow” screen displays “On Battery.”

NOTE: The batteries are fully-charged before shipment. However, transportation and storage inevitably cause some loss of capacity. To ensure adequate back-up time, it is recommended to charge the batteries for at least 8 hours before first start-up.

NOTE: If utility power fails and the batteries are charged, you may cold-start the UPS in battery mode and use battery power to extend system availability for a time.

NOTE: Powering-off the UPS when it is in battery mode results in loss of output power to the connected load.

1.7.4. Frequency Converter Mode

All models of the GXT5 are capable of frequency conversion. Frequency Conversion Mode can be selected using the configuration program. Allowable frequency operating modes include:

- Auto Sensing - 50 Hz or 60 Hz – Bypass Enabled
- Auto Sensing - 50 Hz or 60 Hz – Bypass Disabled
- Frequency Converter - 50 Hz – Bypass Disabled
- Frequency Converter - 60Hz – Bypass Disabled

NOTE: The default for all models of the Liebert® GXT5 is “Auto Sensing - 50 Hz or 60 Hz – Bypass Enabled.”

1.7.5. ECO Mode

The energy-saving ECO mode reduces power consumption by powering the load via bypass if the bypass voltage is normal or by powering the load via the inverter when the bypass voltage is abnormal. You can use ECO mode to power equipment that is not sensitive to power-grid quality to via bypass and reduce power consumption.

NOTE: During ECO mode, if a bypass-failure or abnormal-bypass-voltage notification appears when the output is not overloaded, the UPS will transfer to Normal Mode. However, if a notification showing bypass failure or abnormal bypass voltage appears when the output is overloaded, the UPS will shut down the bypass and therefore the load will shut down.

Chapter 2: Installation

Do not start the UPS until after the installation is finished.



WARNING! Risk of electric shock

Can cause equipment damage, injury and death. Before beginning installation, verify that all external overcurrent protection devices are open (Off), and that they are locked-out and tagged appropriately to prevent activation during the installation, verify with a voltmeter that power is Off and wear appropriate, OSHA-approved personal protective equipment (PPE) per NFPA 70E. Failure to comply can cause serious injury or death. Before proceeding with installation, read all instructions. Follow all local codes.

2.1. Unpacking and Inspection

Unpack the UPS and conduct the following checks:

- Inspect the UPS for shipping damage. If any shipping damage is found, report it to the carrier and your local Vertiv representative immediately.
- Check the accessories included against the packing list. If there is any discrepancy, contact your local Vertiv representative immediately.



CAUTION

The UPS is heavy (see “Specifications” on page 82, for the weight). Take proper precautions when lifting or moving the unit.

2.2. Pre-installation Preparation

- Install the UPS indoors in a controlled environment, where it cannot be accidentally turned Off. The installation environment should meet the specifications listed in “Specifications” on page 82.
- Place the UPS in an area of unrestricted air-flow around the unit, away from water, flammable liquids, gases, corrosives, and conductive contaminants. Avoid direct sunlight.

NOTE: Operating the UPS in temperatures above 77°F (25°C) reduces battery life.

2.2.1. Installation Clearances

Maintain at least 4 in. (100 mm) clearance in the front and rear of the UPS. Do not obstruct the air inlets on the front panel and rear panel of the UPS. Blocking the air inlets reduces ventilation and heat dissipation, shortening the service life of the unit.

2.3. Installing the UPS

The UPS may be installed as a tower or in a rack, depending on available space and use considerations. Determine the type of installation and follow the appropriate instructions. See [Tower Installation](#) or [Rack Installation](#) on next page.

After installing the UPS as a tower or in a rack, and before attempting to start-up, you must install the internal batteries. See [Installing the Internal Battery Kit\(s\)](#) on the next page.

NOTE: When installing the UPS or making input and output connections, comply with all relevant safety codes and standards.

2.3.1. Tower Installation

To install the UPS as a tower:

1. Take the support bases out of the accessories box.

Figure 2-1 Support bases

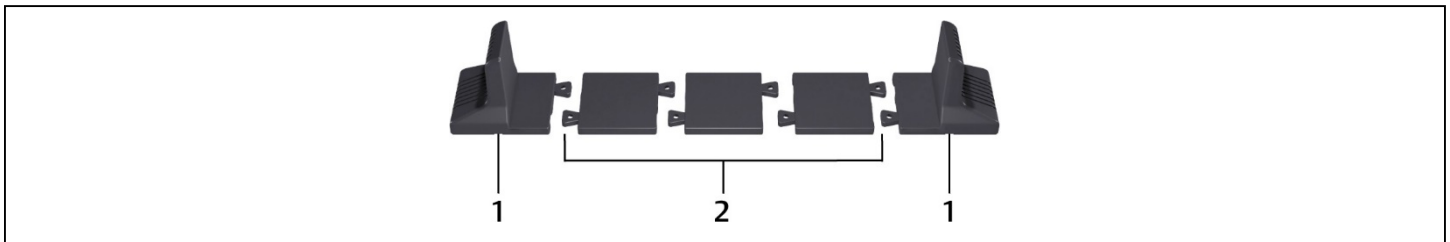

NO.	DESCRIPTION
1	Support bases
2	Spacers with connectors

2. If optional, Liebert® external battery cabinets will be connected, take out the spacers shipped with the battery cabinet.
3. Connect the spacers and the support bases as shown in [Figure 2-1](#) above. Each GXT5 requires 2 support bases, one in the front and one in the rear.
4. Place the GXT5 and any battery cabinets on the 2 support bases.
5. See [Installing the Internal Battery Kit\(s\)](#) on the next page, to install the battery pack(s).

2.3.2. Rack Installation

When installed in a rack enclosure, the GXT5 UPS and external battery cabinets (EBC) must be supported by a shelf or rack-mount rails. Because different rack-mount options install differently, refer to the installation instructions provided with the rack-mount kit.



CAUTION

The GXT5 is heavy. The UPS must be installed as near the bottom of a rack as possible. If placed too high, it can make the rack top-heavy and prone to tipping over. For unit weights, see [Specifications](#) on [page 82](#).

2.4. Installing the Internal Battery Kit(s)

The internal-battery kits are packed separately in boxes and are shipped in main box with the GXT5, which is also in its own box.

1. Loosen and remove the screws on the battery door, see Figure 2.2 below.
2. Lay the battery door and screws aside for reassembly.
3. Unpack the battery pack.
4. Line up and slowly slide the battery pack in until two-thirds of the length is inserted, then pull up slightly and continue pushing in firmly until the battery pack is fully inserted.
5. Attach the battery door with the screws. The battery door will cover the batteries if the packs are properly installed.
6. Attach the front cover to the UPS.

Figure 2-2 Support bases

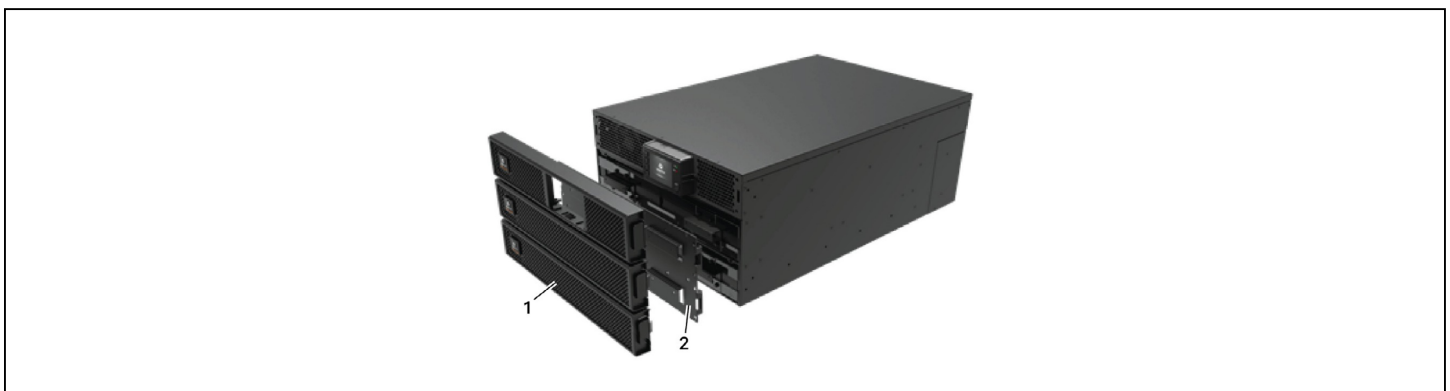

NO.	DESCRIPTION
1	Front Panel
2	Battery Door

2.5. Installing External Battery Cabinets

Optional, external battery cabinets (EBC) may be connected in parallel to the UPS to provide additional battery run time. For approximate battery run times with additional EBCs, see [“Battery Run Times” on page 86](#).

External battery cabinets are placed on one side of the UPS in a tower configuration or stacked beneath the UPS in a rack configuration. Up to 10 EBCs may be connected to the UPS, and up to 6 may be detected using EBC-detection.



WARNING! Risk of electric shock

Can cause injury or death. Disconnect all local and remote electric power supplies before working with the UPS. Ensure that the unit is shut down and power has been disconnected before beginning any maintenance.



CAUTION

The external battery cabinet(s) are heavy, see [Table 7-5 on page 85](#). Take proper precautions when lifting them.

To install the EBC(s):

1. Inspect the EBC for freight damage. Report damage to the carrier and your local dealer or Vertiv representative.
2. For tower installation:
 - An additional set of support-base extensions ships with each EBC.
 - See the steps in [Tower Installation](#), to connect the support extenders and install the bases.
- or -
3. For rack installation:
 - Rack-mount hardware ships with the EBC.
 - Refer to the instructions included with the rack-mount kit to install.

NOTE: Optional slide rails and securing hardware are sold separately. Please contact your Vertiv representative for options and Vertiv Technical Support for assistance.

4. Verify that the EBC breaker is in the “Off” position.
5. Connect the supplied EBC cable(s) to the rear of the cabinet, then to the rear of the UPS, see [Figure 2-3](#).
6. Turn the EBC breaker to the “On” position.
7. Verify the circuit breaker on the EBC is in the “On” position.
The additional back-up run time is enabled.

NOTE: If installing more than 6 EBCs, the user must adjust the number of EBCs manually in Settings > Battery > External battery cabinet group No.

NOTE: When removing an EBC, turn off the circuit breaker on the rear of the cabinet before disconnecting the cable.

NOTE: If shipping or storing the UPS for an extended time, disconnect the EBC(s) minimize stand-by current drain on the batteries and help maintain design life.

Figure 2-3 EBC connection for 5-10K models

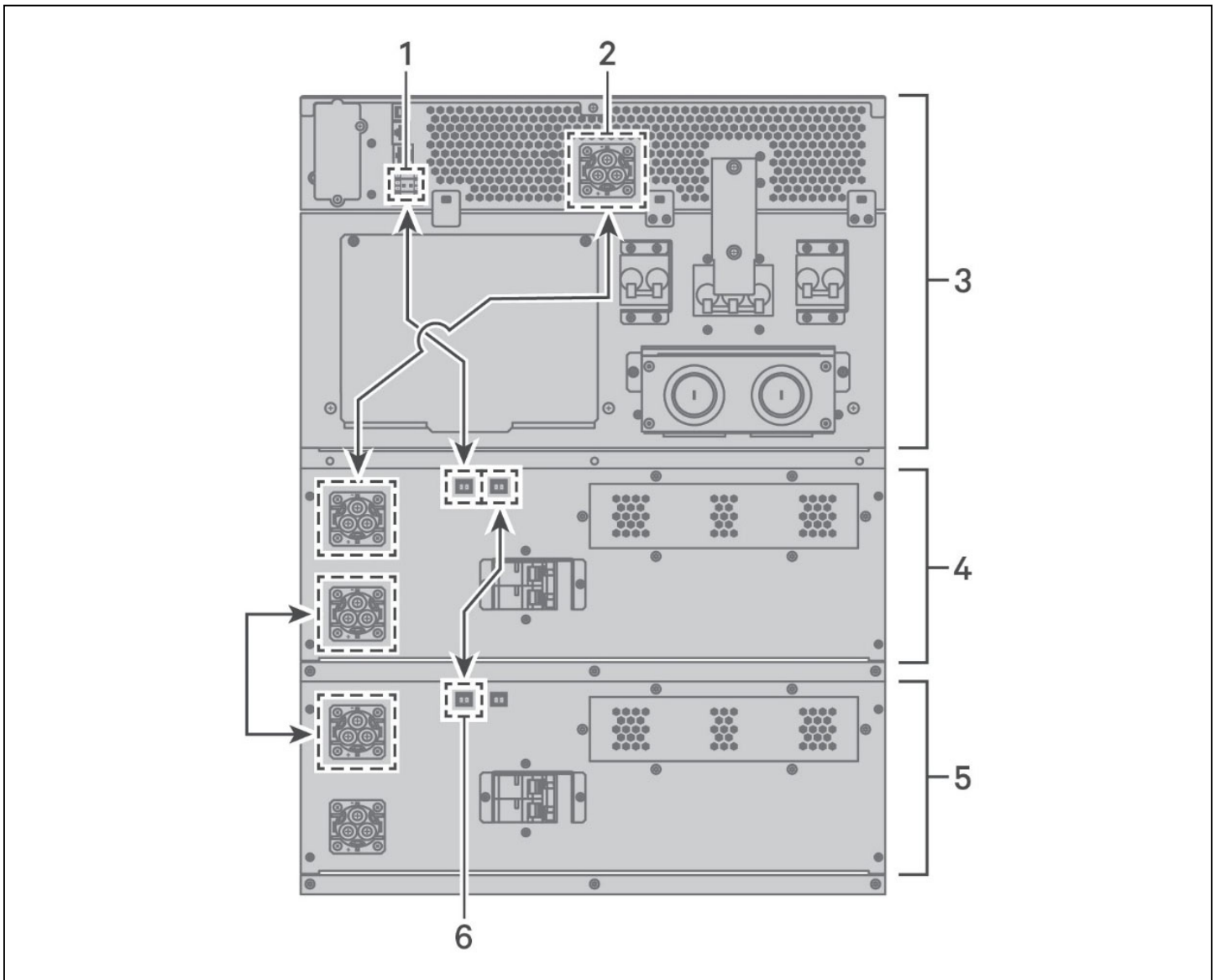

ITEM	DESCRIPTION
1	EBC-detection port (See Table 2-2 on page 27 , for details.)
2	EBC connector
3	UPS
4	External battery cabinet
5	External battery cabinet
6	EBC-detection port

Figure 2-4 EBC connection for 15-20K models

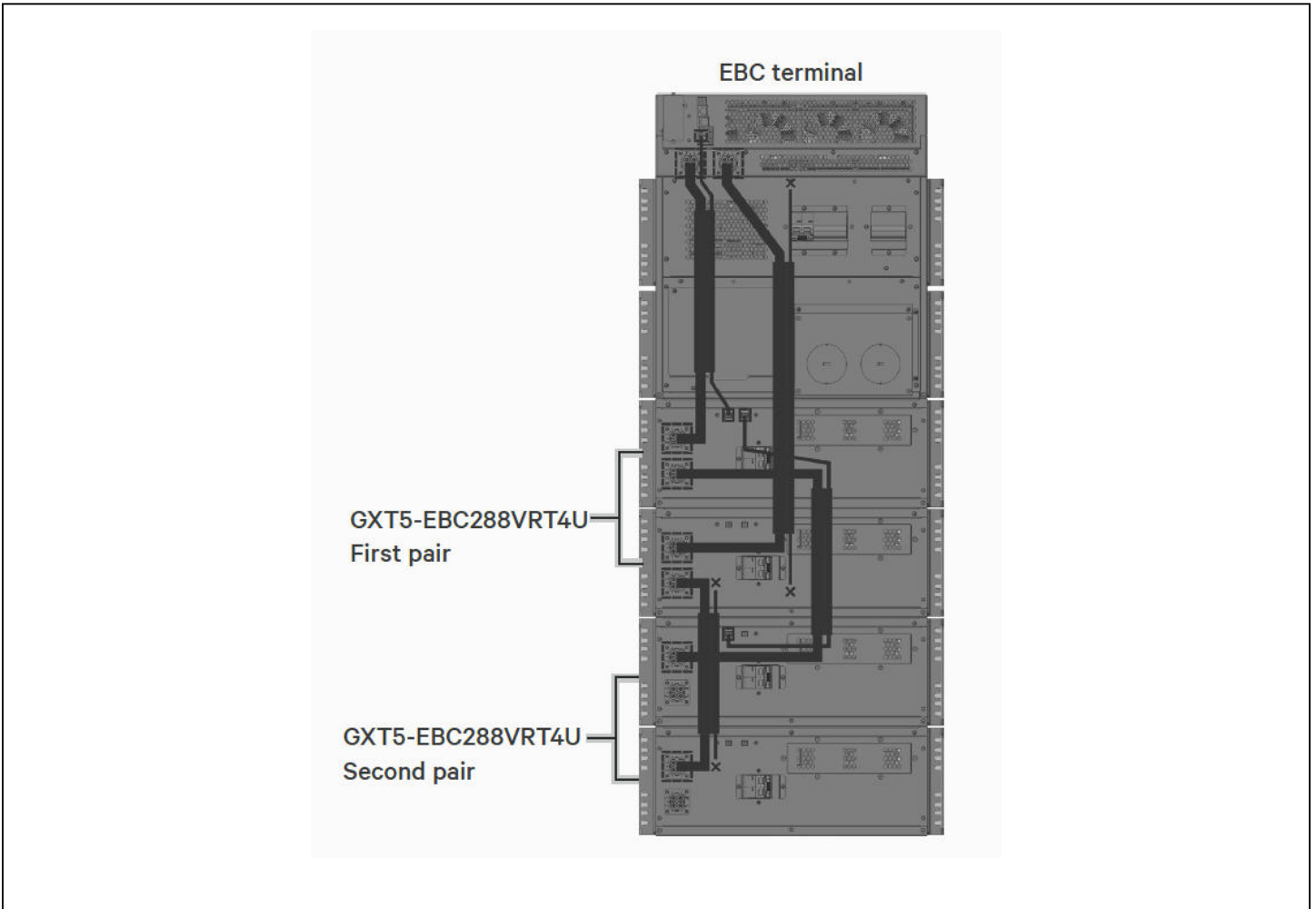

2.6. Installing a Power-output Distribution Box

- PD5-UL6HDWR-MBS, PD5-001, PD5-002, PD5-003, PD5-004, PD5-005 and PD5-006 models fit the GXT5-5000MVRT4UXLN and GXT5-6000MVRT4UXLN models of the Liebert GXT5
- PD5-UL10HDWR-MBS, PD2-101, PD2-102, PD2-103, PD2-104, PD2-105, PD2-106, PD2-107, PD2-108, PD2-109, PD2-200, PD2-201, PD2-202, PD2-204 models fit the GXT5-8000MVRT6UXLN and GXT5-10KMVRT6UXLN models of the Liebert GXT5

2.6.1. Installing the Power Distribution Box on GXT5-5000MVRT4UXLN and GXT5-6000MVRT4UXLN Models

PD5-UL6HDWR-MBS, PD5-001, PD5-002, PD5-003, PD5-004, PD5-005 and PD5-006 models assemble steps as follows:

1. Align the connectors and press the power-distribution box onto the UPS.
2. Hold the box firmly against the UPS and tighten the captive screws except the one over the maintenance bypass breaker cover.
3. Confirm the maintenance bypass breaker “Off.”
4. Loosen the maintenance captive screw over the maintenance bypass breaker cover, pull down the cover and tight another screw that on the UPS side.
5. Turn the output and input breakers “On.”
6. Start the UPS according to start-up instructions.

2.6.2. Installing the Power Distribution Box on GXT5-8000MVRT6UXLN and GXT5-10KMVRT6UXLN Models

PD2-101, PD2-102, PD2-103, PD2-104, PD2-105, PD2-106, PD2-107, PD2-108, PD2-109, PD2-200, PD2-201, PD2-202, PD2-204 models assemble steps as follows:



WARNING! Risk of electric shock

Can cause injury or death. The UPS must be shut down or the load must be transferred to an external maintenance bypass before a power distribution box may be added, changed or removed. If the UPS will be shut down, the connected load must be shut down. If the UPS will be transferred to maintenance bypass, it must be transferred to an external maintenance bypass. Verify that the GXT5 is shut down and that all local and remote electric input power has been disconnected before beginning any work on or in the UPS.

1. With the cover of distribution box removed, Connect the UPS and distribution box connectors together. Ensure that the connectors are fully connected.
2. Align the screw holes and press the power distribution box onto the UPS, making sure that the tabs at the bottom of the box fit into the slots on the UPS.
3. Attach the box to the UPS by installing screws into the two holes at the top of the box.
4. Tighten the screws.
5. Turn the output and input breakers On.
6. Start the UPS according to start-up instructions.

2.7. Removing the Power Distribution Box from GXT5-5000MVRT4UXLN and GXT5-6000MVRT4UXLN Models

PD5-UL6HDWR-MBS, PD5-001, PD5-002, PD5-003, PD5-004, PD5-005 and PD5-006 models remove steps as follows:

1. Manually transfer the connected equipment to the internal bypass.
 - a. From the main menu select CONTROL, then press Enter.
 - b. Select Turn on / off/ to bypass and press Enter.
 - c. Select Turn to bypass and press Enter.

The UPS transfers the connected loads to the internal bypass.

- d. Loosen the maintenance captive screw over the maintenance bypass breaker cover, pull up the cover and tight another screw, ensure the screw is on the "ON" location. (see the following figure for the breaker's location).
- e. Turn the maintenance bypass breaker On.

NOTE: The load is unprotected from disturbances in the power supply while the UPS is on bypass.

2. Please wait 1 minute If the UPS work on battery mode, then confirm the UPS is turn off.
3. Turn the output and input breakers Off.
4. Loosen other captive screws until the power distribution box releases.
5. Remove the power distribution box from the UPS and set it aside.
6. On the rear of the panel, loosen the screws of the protective cover for the connectors, slide it over the connectors, and tighten the screws.

Figure 2-5 Power distribution box removal from GXT5-5000MVRT4UXLN and GXT5-6000MVRT4UXLN

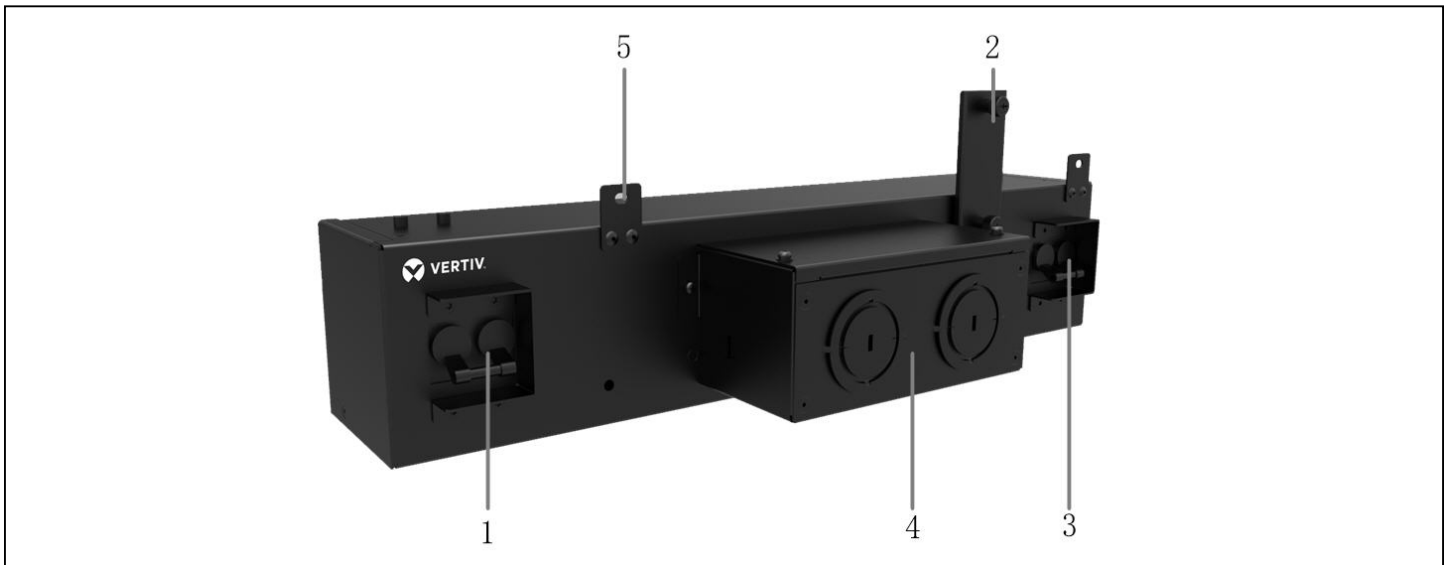

ITEM	DESCRIPTION
1	Output breaker
2	Maintenance bypass breaker screw
3	Input breaker
4	Knockouts for hard-wired power input and output
5	Screws

2.8. Removing the Power Distribution Box from GXT5-8000MVRT6UXLN and GXT5-10KMVRT6UXLN Models

PD2-101, PD2-102, PD2-103, PD2-104, PD2-105, PD2-106, PD2-107, PD2-108, PD2-109, PD2-200, PD2-201, PD2-202, PD2-204 models remove steps as follows:

1. Shut down the GXT5.
 - a. From the Main Menu select CONTROL, press Enter, then select Turn on / off/to bypass.
 - b. Press the enter key.
 - c. Select Turn off UPS, then press Enter. Power to the connected loads is now Off.
2. Turn the output and input breakers Off.
3. Support the power distribution box and remove the two screws at the top of the box.
4. Remove the cover for power-distribution box from the UPS and set it aside.
5. If removing a power-distribution box, carefully pull apart the power-distribution-box connector and the UPS connector.

Figure 2-6 Power distribution box removal from GXT5-8000MVRT6UXLN and GXT5-10KMVRT6UXLN models

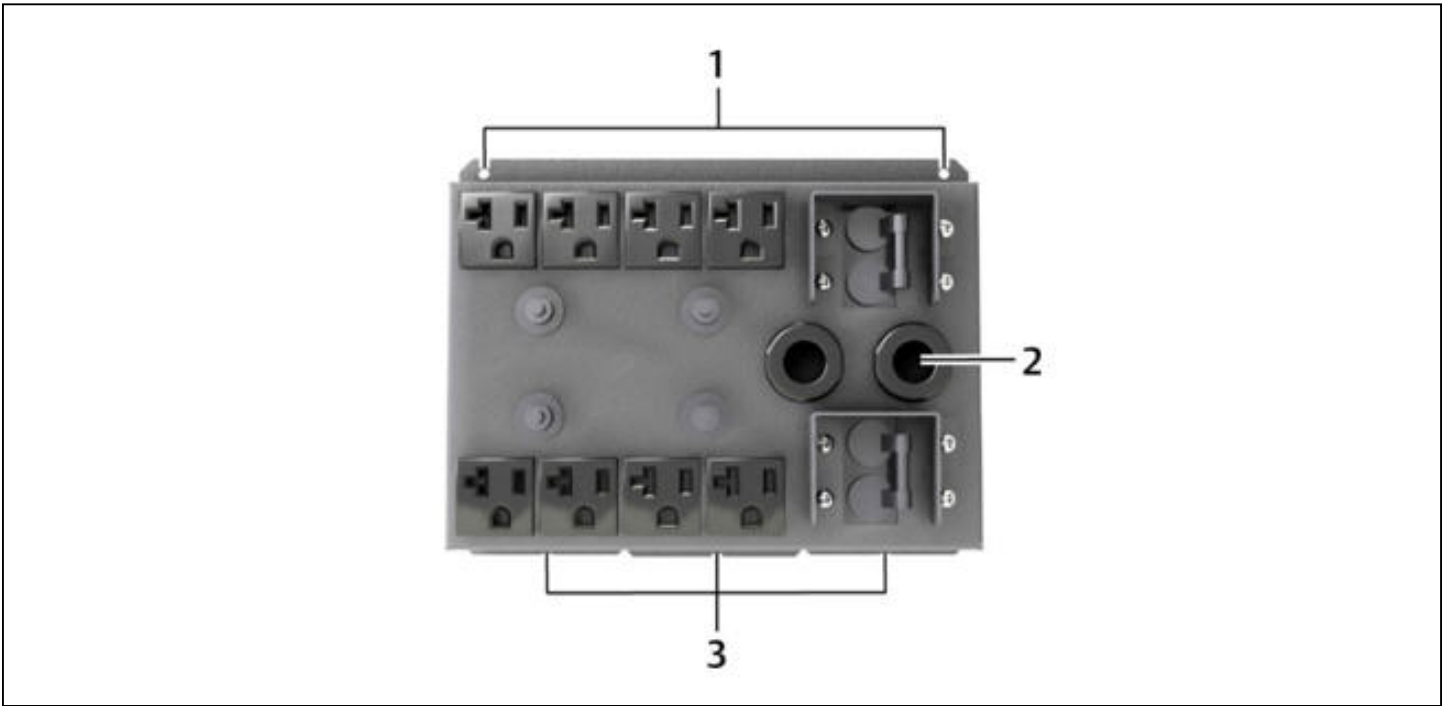

ITEM	DESCRIPTION
1	Remove screws
2	Pigtails removed for clarity
3	Tabs slip into slots on the UPS

2.9. Hardwired Input/Output Connections

! WARNING! Risk of electric shock

Can cause equipment damage, injury and death. Before beginning installation, verify that all external over-current protection devices are open (Off), and that they are locked-out and tagged appropriately to prevent activation during the installation, verify with a voltmeter that power is Off and wear appropriate, OSHA-approved personal protective equipment (PPE) per NFPA 70E. Failure to comply can cause serious injury or death. Before proceeding with installation, read all instructions. Follow all local codes.

Observe the following guidelines and specifications when making the hard-wire input and output connections:

- We recommend installing a UL489-approved breaker upstream of unit.
- Provide circuit-breaker protection according to local codes. The mains disconnect should be within sight of the UPS or have an appropriate lock-out.
- Maintain service space around the UPS or use flexible conduit.
- Provide output-distributions panels, circuit-breaker protection, or emergency disconnects according to local codes.

- Do not install input and output wiring in the same conduit.
- On models with a cord-connected input plug that is used as the power-disconnect device, the UPS must be installed near a wall socket or outlet that is easily accessible per the National Electric Code/NFPA 70 requirements. Models/POD options subject to this requirement are: GXT5-5000MVRT4UXLN and GXT5-6000MVRT4UXLN with POD PD5-001, PD5-002, PD5-003, PD5-004, PD5-005, or PD5-006

2.9.1. Branch Circuit Breaker

The installer must provide an upstream branch circuit breaker, see [Table 2-1](#) below, for the ratings. The input circuit breaker on the distribution box and the output circuit breaker on the rear of the power distribution box disconnect all power between the main cabinet and the distribution box. [Figure 2-7](#) on the next page, shows a diagram of the circuit breakers.

Observe the following guidelines and specifications when making the hard-wire input and output connections:

- Provide circuit-breaker protection according to local codes. The mains disconnect should be within sight of the UPS or have an appropriate lock-out.
- Maintain service space around the UPS or use flexible conduit.
- Provide output-distributions panels, circuit-breaker protection, or emergency disconnects according to local codes.
- Do not install input and output wiring in the same conduit.

Models equipped with a manual bypass breaker pass bypass power directly to the bypass breaker from the input terminal block. The input circuit breaker on the distribution box does not disconnect power from the manual bypass breaker.

Table 2-1 Branch circuit breaker rating

MODEL NUMBER	RECOMMENDED EXTERNAL CIRCUIT BREAKER	RECOMMENDED EXTERNAL OVERCURRENT PROTECTION WHEN USING OPTIONAL PODS
GXT5-5000MVRT4UXLN	40A	30A
GXT5-6000MVRT4UXLN	40A	30A
GXT5-8000MVRT6UXLN	60A	
GXT5-10KMVRT6UXLN	60A	
GXT5-15KMVRT11UXLN	125A	
GXT5-20KMVRT11UXLN	125A	

Figure 2-7 Circuit-breakers diagram

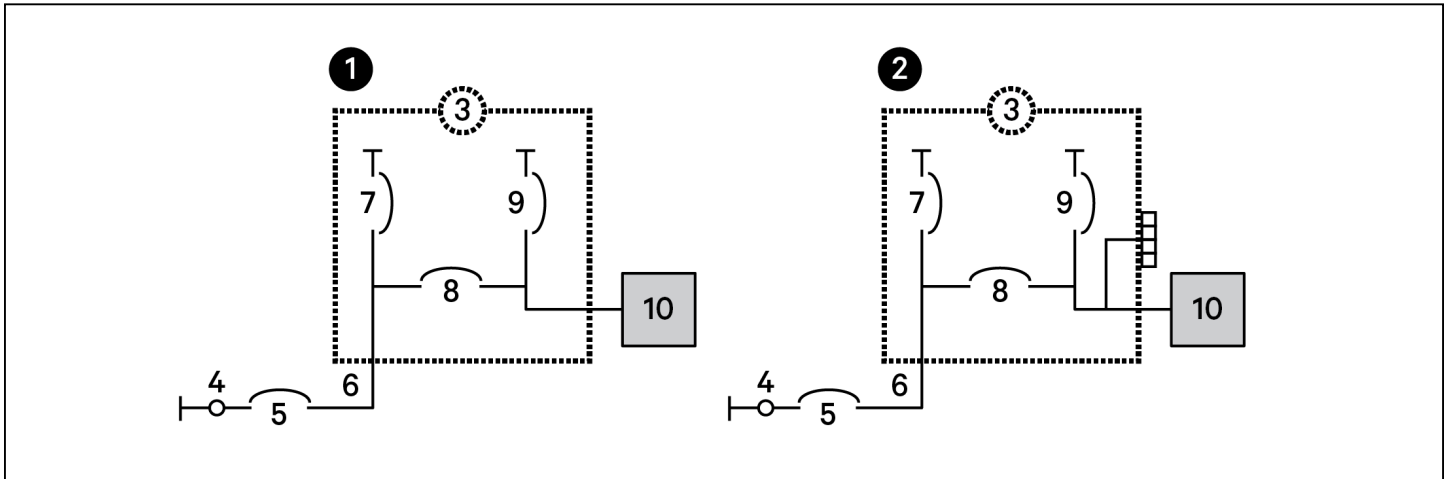

ITEM	DESCRIPTION
1	5-kVA and 6-kVA models
2	8-kVA through 20-kVA models
3	UPS
4	Mains/Utility
5	External branch circuit breaker
6	Input
7	Input circuit breaker
8	Maintenance bypass circuit breaker NOTE: 15-kVA and 20-kVA models do not include maintenance bypass
9	Output circuit breaker
10	Output-distribution POD

2.9.2. Terminal-block Connections

On 5-kVA through 10-kVA models, the hard-wire connections to the terminal blocks are made through knockouts on the standard POD attached to the rear of the unit. On 15-kVA and 20-kVA models, the knockouts are located directly on the rear of the unit. See [Removable Power Distribution Box](#) on [page 8](#), for the location of the input/output knockouts on your GXT5 model.

[Table 2-2](#) on the next page, details the electrical-connection specifications.

Table 2-2 Terminal-block electrical specifications

UPS MODEL	RECOMMENDED EXTERNAL CIRCUIT BREAKER	RECOMMENDED WIRE SIZE (ALL WIRES) (90°C COPPER WIRE)	MAXIMUM WIRE SIZE ACCEPTED BY TERMINAL BLOCK	TERMINAL TIGHTENING TORQUE
GXT5-5000MVRT4UXLN	40 A	10 AWG	4 AWG	20 lb-in (2.26 Nm)
GXT5-6000MVRT4UXLN		8 AWG		
GXT5-8000MVRT6UXLN	60 A	6 AWG		
GXT5-10KMVRT6UXLN				
GXT5-15KMVRT11UXLN	125 A	1 AWG	1/0 AWG	110 lb-in (5.65 Nm)
GXT5-20KMVRT11UXLN		1/0 AWG		

To make the terminal-block connections:

1. Loosen the screws from the cable-entry/conduit-box cover, and pull the cables through the cable-entry hole/knockout leaving some slack for connection.

NOTE: We recommend using the knockouts to install input and output wiring in separate conduit. You must use a suitable cable gland or risk electric shock.

2. Referring to the appropriate terminal-block connection instructions, connect the cables to the corresponding input/output terminals and use a torque wrench to turn the screw clockwise until tightened as specified in [Table 2-2](#) above.
3. Re-install the cable-entry/conduit-box cover, and tighten the screws.

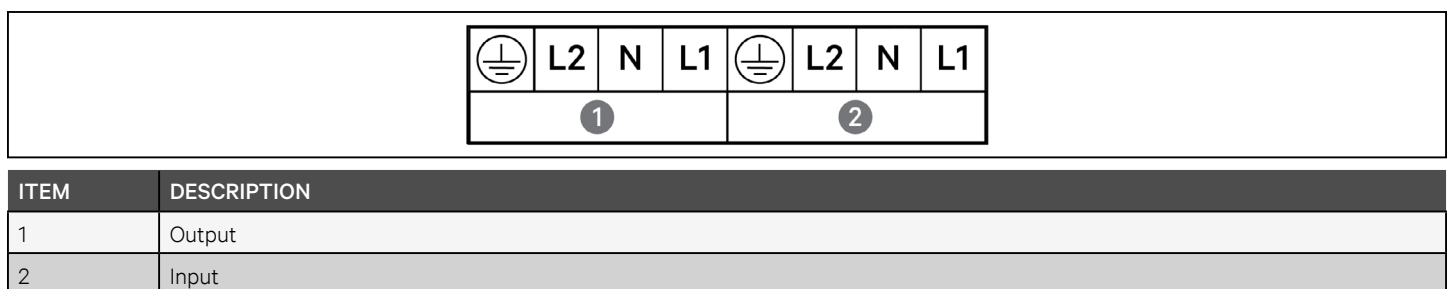
Figure 2-8 Terminal Block

2.10. Communication Connections

The UPS offers several communication interfaces and ports.

NOTE: We recommend that signal-cable lengths be less than 10 ft (3 m), and are kept away from power cabling.

2.10.1. Connecting IntelliSlot Communication

The Liebert® IntelliSlot™ RDU101 provides SNMP monitoring of the UPS across the network and/or building management system.

See the appropriate figure for your model in [Rear Panels](#) on [page 5](#), for the location of the card port.

To install an IntelliSlot Card:

1. Remove the screws from the slot cover plate and remove the plate.
2. Insert the card into the slot, and secure with the screws that held the cover plate.

To make connections to the card, refer to the Installer/User Guide for the appropriate IntelliSlot card available at www.Vertiv.com.

2.10.2. Connecting to the Dry-contact Port

The UPS includes a dry-contact port. See the appropriate figure for your model in [Rear Panels](#) on [page 5](#), for the location of the port. [Figure 2-9](#) below, shows the ports and [Table 2-3](#) on the next page, describes each port.

The I/O dry contact port capacity is 125 Vac, 0.5 A; 30 Vdc, 1 A.

Figure 2-9 Dry-contact Port and Pin Layout

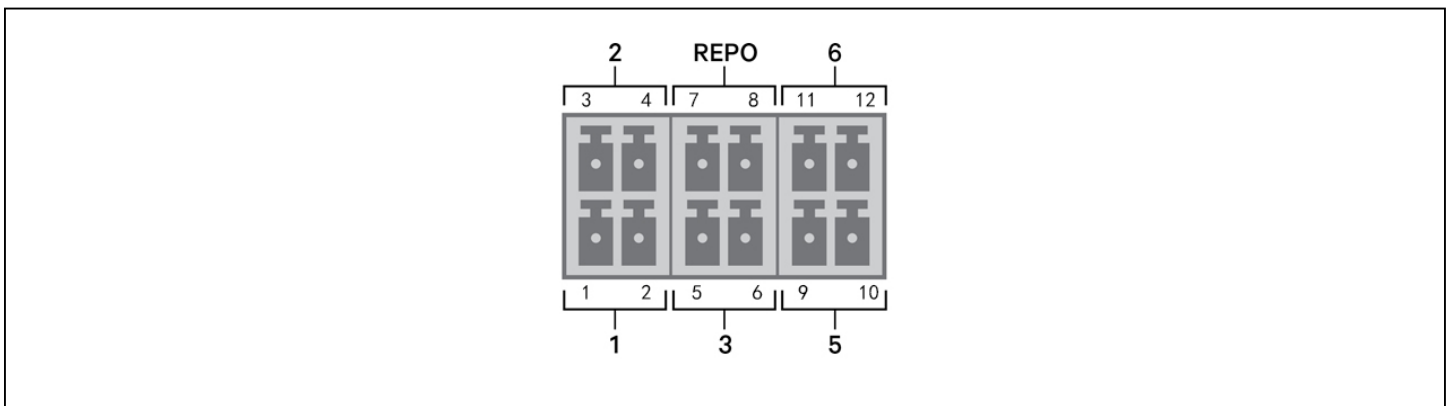

NOTE: Pins 7 and 8 are shorted before delivery.

NOTE: The emergency power-off (EPO) action of the UPS closes the rectifier, inverter and static bypass, but it cannot disconnect the UPS mains input inside. To completely disconnect the UPS, disconnect the upstream input circuit breaker when generating the EPO. For details on REPO connection and operation, see [“Connecting a Remote Emergency Power-off \(REPO\) Switch” on page 30](#) on the next page.

Table 2-3 Dry-contact Connection and Pin-out Descriptions

PORT NO.	PORT NAME	PIN NO.	PIN NAME	DESCRIPTION
1	Input 1	1	Remote Comms Shutdown 1	User configurable dry-contact input that can be set to trigger the events below. The user can also select the dry-contact as either NO or NC. (See System parameter options on page 37) When NO, Pins 1 and 2 are shorted to trigger the event. When NC, Pins 1 and 2 are opened to trigger the event. Options are: <ul style="list-style-type: none"> • Disable (default) • Battery mode shutdown - If the UPS is running on batteries and this input is triggered, the UPS shuts down • Any mode shutdown - If this input is triggered, the UPS shuts down regardless of current operating mode
		2	Signal Ground	Signal Ground
2	Input 2	3	Remote Comms Shutdown 2	User configurable dry-contact input that can be set to trigger the events below. The user can also select the dry-contact as either NO or NC. (See System parameter options on page 37) When NO, Pins 3 and 4 are shorted to trigger the event. When NC, Pins 3 and 4 are opened to trigger the event. Options are: <ul style="list-style-type: none"> • Disable (default) • Battery mode shutdown - If the UPS is running on batteries and this input is triggered, the UPS shuts down • Any mode shutdown - If this input is triggered, the UPS shuts down regardless of current operating mode.
		4	Signal Ground	Signal Ground
3	Battery Detection	5	EBC Detection	Automatically detects number of external- battery cabinets when pins 5 and 6 are connected to the detection port, see “Installing External Battery Cabinets” on page 18 .
		6	EBC Detection	Automatically detects number of external- battery cabinets when pins 5 and 6 are connected to the detection port, see “Installing External Battery Cabinets” on page 18 .
REPO	REPO Input	7	+5V	REPO power supply, 5-Vdc 100-mA.
		8	REPO Coil -NC	NC, activated when Pin 7 and Pin 8 is open NOTE: For details on REPO connection and operation, see “Connecting a Remote Emergency Power-off (REPO) Switch” on page 30.
5	Output 5	9, 10	Remote Fault Alert 5	User configurable dry-contact output that can be set to alert the user to the faults below. The user can also select the dry-contact as either NO or NC. (See System parameter options on page 37) When NO, Pins 9 and 10 are shorted when the fault occurs. When NC, Pins 9 and 10 are opened when the fault occurs. Options are: <ul style="list-style-type: none"> • Low battery (default) • On battery • On bypass • UPS fault
6	Output 6	11, 12	Remote Fault Alert 6	User configurable dry-contact output that can be set to alert the user to the faults below. The user can also select the dry-contact as either NO or NC. (See System parameter options on page 37) When NO, Pins 11 and 12 are shorted when the fault occurs. When NC, Pins 11 and 12 are opened when the fault occurs. Options are: <ul style="list-style-type: none"> • Low battery • On battery • On bypass • UPS fault (default)

2.10.3. Connecting a Remote Emergency Power-off (REPO) Switch

The UPS includes an EPO connection in the dry-contact port. See the appropriate figure for your model in [Rear Panels](#) on [page 5](#), for the location of the port.

UPS ships with a REPO jumper installed, allowing the UPS to operate as a normally-closed switch system (fail-safe). Opening the circuit disables the UPS. To connect a REPO switch that opens the circuit to shut down the rectifier and inverter and power-off the UPS, use a cable from the remote switch to plug into the REPO-port on the UPS.

In normal conditions, the REPO switch cannot cut off the UPS input power. When the REPO switch trips, the UPS generates an alarm and immediately cuts-off output power. When the emergency condition is resolved, the UPS will not return to normal operation until you reset the REPO switch and manually power- on the UPS.

To make the cable for the REPO connection:

[Figure 2-10](#) below, shows the cable required to make the connection. We recommend using 18 AWG to 22 AWG (0.82 mm² to 0.33 mm²) copper-core cable.

1. Remove the insulation from the end of two cables.
2. Insert the stripped end into the plug terminals 1 and 2 respectively, then press down the terminals. Make sure that the cables are secure in the plug to prevent failure because of loose contact.

To connect a UPS to the REPO switch.



CAUTION

To maintain safety (SELV) barriers and electromagnetic compatibility, signal cables should be shielded and run separately from power cables.

1. Connect one end of the cable to the remote switch, see [Figure 2-10](#) below.
2. Remove the factory-installed jumper from pins 7 and 8 of the dry-contact port on the UPS
3. Connect the plug to pins 7 and 8.

Figure 2-10 Cable/Plug for Connecting REPO switch to UPS REPO port

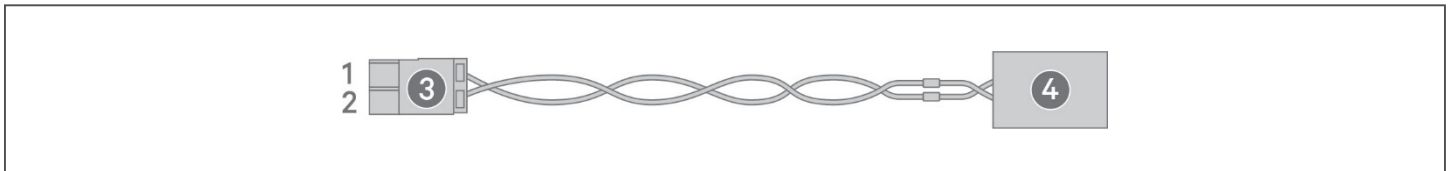

ITEM	DESCRIPTION
1	Terminal 1
2	Terminal 2
3	Plug (connects to REPO port on UPS)
4	REPO switch

2.10.4. Connecting a USB Cable

The UPS includes a USB connector. See the appropriate figure for your model in [Rear Panels on page 5](#), for the location of the port.

The standard, B-type USB port connects the UPS to a network server or other computer system. The USB port supports HID/CDC protocol. The CDC protocol is reserved for service software. To use the HID protocol for monitoring, get Power Assist from www.vertiv.com.

2.10.5. Connecting CLI Communication Cables

The UPS supports the Vertiv command-line interface for operation with Vertiv ACS and other third-party monitoring protocols. The RJ-45 port (labeled “R232”) is used for CLI connection. See the appropriate figure for your model in [Rear Panels on page 5](#), for the location of the port. The pin-out, described in below table is consistent with the ACS pin-out.

ITEM	DESCRIPTION
1	NC
2	NC
3	TXD (out)
4	GND
5	NC
6	RXD (in)
7	NC
8	NC

This page is intentionally left blank.

Chapter 3: Operating the UPS



WARNING! Risk of electric shock

Can cause injury or death. Hazardous mains and/or battery voltage exists behind the protective cover. No user accessible parts are located behind the protective covers that require a tool for removal. Only qualified service personnel are authorized to remove such covers. If maintenance for rack is needed, notice that the neutral line is live.

3.1. Silencing the Audible Alarm

The audible alarm may sound during UPS operation. To silence the alarm, press and hold the ESC button for 2 seconds. The button is located on the front-panel display, see [“Operation and Display Panel” on page 37](#).

3.2. Starting-up the UPS

IMPORTANT! Do not start the UPS until after the installation is finished, the system is commissioned by an authorized engineer, and the external input circuit breakers are closed.



CAUTION

Starting the UPS applies mains/utility power to the output terminals. Make sure that the load power is safe and ready to accept power. If the load is not ready, isolate the load with the output terminal.

The UPS starts in Normal Mode.

To start the UPS:

1. If included on your UPS model, make sure the maintenance-bypass switch is in the open “OFF” position and that the guard is secured in place.
2. Ensure that the REPO connector on the rear of the unit has a jumper between pins 7-8 or that it is properly wired to an Emergency Power- Off circuit (normally closed).
3. Make sure the breaker supplying power to the UPS is closed, and if necessary press the input circuit breaker reset buttons at the rear of the UPS.
4. If included on your UPS model, close the bypass breaker on the rear of the UPS.
5. Close all output breakers on the rear of the UPS (or in an external panel board, if used).
6. If external battery cabinets are attached, close the breakers on the rear of each cabinet.
7. Power-on the UPS by pressing and holding the power button on the operation and display panel until the confirmation dialog appears. Use the Up/ Down arrows to select YES, then press **Enter**.
8. If this is the first-time start-up of the UPS, the Start-up Guidance wizard opens to set the basic parameters of the UPS. Follow the prompts.

For detailed description of UPS display functions and settings, see [“Operation and Display Panel”](#) on page 37.

3.3. Transferring to Battery Mode

The UPS operates in Normal mode unless the mains/utility power fails or it is performing a battery self test, then it automatically transfers to Battery mode for the back-up time available or the mains/utility power is restored. Once input power is restored, the UPS returns to Normal mode.

NOTE: Battery back-up run times are listed in [“Battery Run Times”](#) on page 86.

3.4. Transferring from Normal to Bypass Mode

Press and hold the power button for 2 seconds.

If the UPS is operating normally, without faults, the option to continue to turn-on or turn-off the UPS displays:

- a. Use the arrow buttons to select *Turn on UPS* or *Turn off UPS*, and press **Enter**.
- b. Use the arrow buttons to select *No* or *Yes*, then press **Enter** to confirm.

If the bypass power is outside normal operating range, the option turn-off the UPS displays. Use the arrow buttons to select *No* or *Yes*, then press **Enter** to confirm.

3.5. Transferring from Bypass to Normal Mode

Press and hold the power button for 2 seconds.

If the UPS is operating normally, without faults, the option to continue to turn-on or turn-off the UPS displays:

- a. Use the arrow buttons to select *Turn on UPS* or *Turn off UPS*, and press **Enter**.
- b. Use the arrow buttons to select *No* or *Yes*, then press **Enter** to confirm.

NOTE: The UPS automatically switches back to normal mode after an “overheated” or “overloaded” fault is cleared and normal power is restored.

3.6. Shutting-down the UPS Completely



WARNING! Risk of electric shock

Can cause injury or death. Disconnect all local and remote electric power supplies before working with the UPS. Ensure that the unit is shut down and power has been disconnected before beginning any maintenance.

Transfer to Bypass mode, see [“Transferring from Bypass to Normal Mode”](#) on page 34. Then, if power to the load is not needed, open the main-input circuit breaker.

For systems with direct power distribution, isolate the UPS from AC power by disconnecting the external input MCB. If the main and bypass are independently powered, close the two input MCBs.

3.7. Remote Emergency Power-off (REPO)

REPO turns off the UPS in emergency conditions such as fire or flood. When an emergency occurs, the REPO switch turns off the rectifier and inverter and stops powering the load immediately. The battery stops charging and discharging.

To manually power-off in an emergency, disconnect the terminal connecting the REPO port on the rear of the UPS.

If mains/utility power is present, the UPS control circuit remains active even though output power is disabled. To remove all mains/utility power, disconnect the external main-input circuit breaker.

This page is intentionally left blank.

Chapter 4: Operation and Display Panel



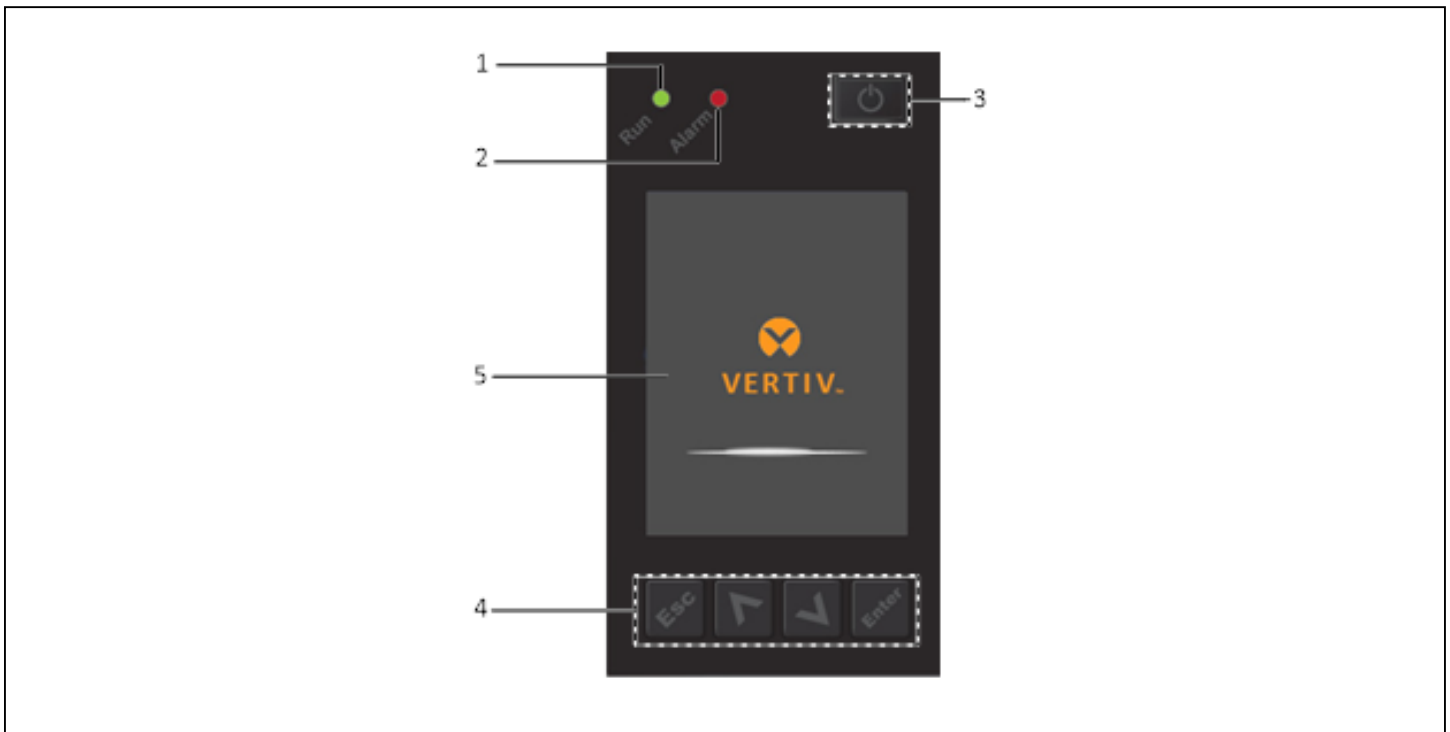

The operation/display panel includes LED indicators, function keys, and an LCD interface to configure and control UPS operation.

Figure 4-1 UPS Front-panel Display



ITEM	DESCRIPTION
1	Run indicator LED, see "LED Indicators" on page 39.
2	Alarm indicator LED, see "LED Indicators" on page 39.
3	Power button, see Table 4-1 on the next page.
4	Menu keys, see Table 4-1 on the next page.
5	LCD panel.

Table 4-1 Display-panel Button Functions and Descriptions

BUTTON	FUNCTION	DESCRIPTION
	Enter	Confirm or enter selection.
	Up	Move to previous page, increase value, move left.
	Down	Move to next page, decrease value, move right.
	Escape	Go back.
	Power	Power-on the UPS, power-off the UPS, transfer to Bypass Mode.

NOTE: While the UPS is operating, the LCD will dim and display a screen saver if there is no active alarm or user interaction for two minutes, see [Figure 4-2](#). If an alarm or fault occurs or if any button is pressed, the UPS-flow screen displays.

Figure 4-2 LCD Screen Saver



4.1. LED Indicators

The LEDs on the front-panel display indicate operation and alarm statuses of the UPS.

NOTE: When an alarm is indicated, an alarm message is logged on [page 55](#), describes the alarm messages you may see. When a fault is indicated, front-panel display list the fault, which are described in [Table 6-2 on page 79](#).

Table 4-2 LED Functions

INDICATOR	LED COLOR	LED STATE	INDICATES
Run indicator	Green	On	UPS has output
		Blinking	Inverter is starting
		Off	UPS has no output
Alarm indicator	Yellow	On	Alarm occurs
	Red	On	Fault occurs
	None	Off	No alarm, no fault

4.2. LCD Menu and Screens

The menu-driven LCD user interface lets you browse the UPS status, view operating parameters, customize settings, control operation, and view alarm/event history. Use the function keys to navigate through the menu, and view statuses or select settings in the screens.

4.2.1. Start-up and Flow Screens

At start-up, the UPS executes a system test and displays the Vertiv logo screen for about 10 seconds, shown in [Figure 4-1 on page 37](#). After the test completes, an overview screen shows status information, the active (green) power path, and the non-working power path (gray).

NOTE: [Figure 4-3](#) is an example flow screen and does not reflect the actual values that you may see on your unit.

Figure 4-3 UPS Flow Screen

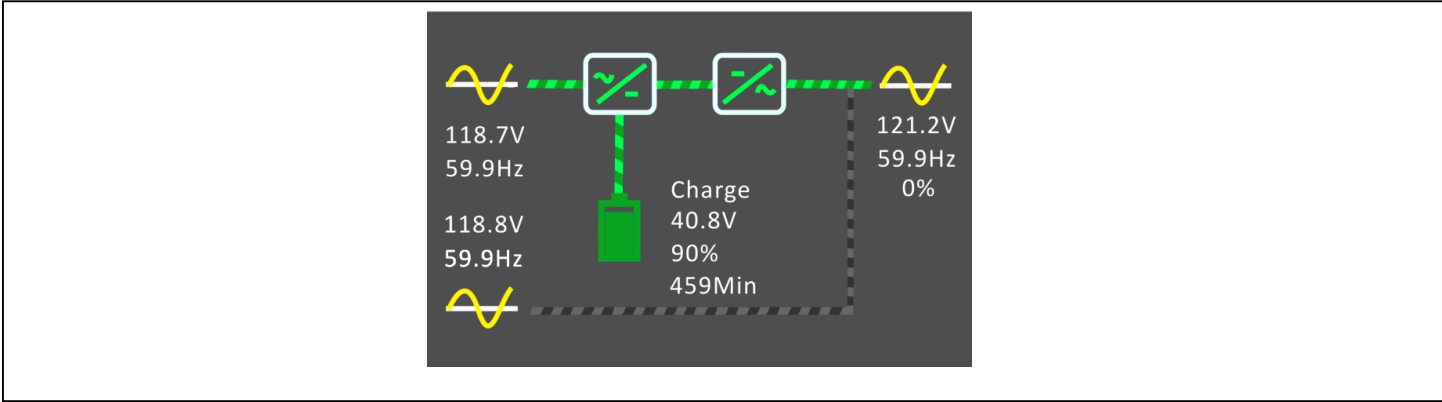

4.2.2. Main Menu

To access the main menu, press **Enter** while at the flow screen. [Table 4-3](#) below, describes the menu options, and [Figure 4-4](#) below, describes the display.

Use the arrow buttons to select the sub-menu options, and press **Enter** to open the sub menu. Press ESC to return to the flow.

Table 4-3 Menu Options

SUB MENU	DESCRIPTION
Status	Voltage, current, frequency, and parameters for UPS components, see Status Screen on the facing page.
Settings	Display and system parameter settings, see Settings Submenu on page 45 .
Control	UPS controls, see Control Screen on page 53 .
Log	Current alarms and event history, see Log Screen on page 55 .
About	Product and network information, see About Screen on page 58 .
Maintenance	Service-only, service-password protected page for use only by Vertiv service representatives.

Figure 4-4 Main Menu

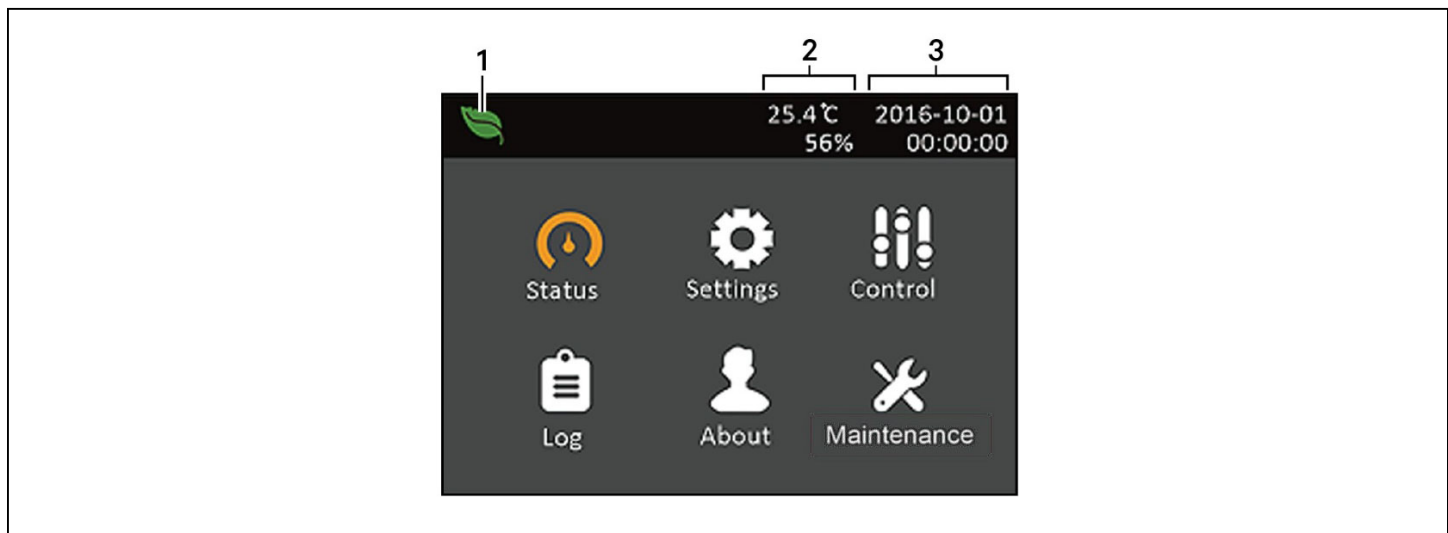

ITEM	DESCRIPTION
1	ECO-mode indicator
2	Programmable-outlet indicator
3	Ambient temperature and humidity. Only displays when sensors are connected.

4.2.3. Status Screen

The status screen displays voltages, currents, frequencies, and parameters on individual tabs for input, bypass, battery, output, and load status.

To view the UPS status information:

1. At the main menu, select the Status icon, and press **Enter**.
2. Use the arrow buttons to move the cursor left/right and select a tab, then press **Enter** to display the status information for the selected tab.

Figure 4-5 Status-screen tabs

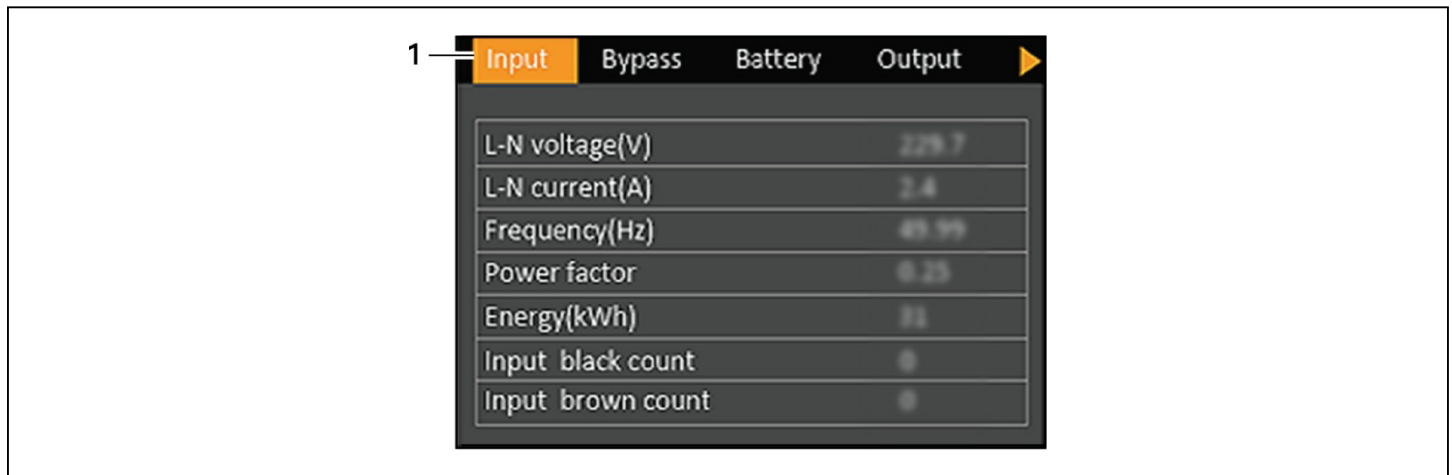

ITEM	DESCRIPTION
1	Screen tabs with Input tab selected

NOTE: Multiple phases are shown in multiple columns. For example, a unit with 3-phase input will display 3 columns of status data.

Input Status Options

L-N voltage (V)

Line-neutral voltage of input power.

L-N current (A)

Line-neutral current of input power.

Frequency (Hz)

Frequency of input of input power.

L-L voltage(V)

Line-line voltage of input power.

Power Factor

Power factor of the input power.

Energy (kWh)

Input power.

Input black count

The number times that the input voltage was lost or dropped below 60 VAC (black out). Resets to 0 when UPS is powered down.

Input brown count

The number of times that the input voltage was too low to support the load and the UPS was forced to switch to battery power (brown out). Resets to 0 when the UPS is powered down.

Bypass Status Options**L-N voltage (V)**

Line-neutral voltage of bypass power.

Frequency (Hz)

Frequency of bypass power.

L-L voltage(V)

Line-line voltage of bypass power.

Battery Status Options**Battery status**

Current battery state: charging, discharging, or fully-charged.

Battery voltage (V)

Voltage of battery power.

Battery current (A)

Current of battery power.

Backup time (Min)

Amount of back-up time remaining for battery.

Remaining capacity (%)

Percent of capacity remaining for battery.

Discharge count

Number of discharges for the battery module.

Total discharge time (Min)

Number of minutes until battery is fully discharged.

Battery running time (Day)

Number of days the batteries have been in operation.

Battery replacement time

Date of last time battery was replaced.

External battery cabinet group No.

Number of external battery cabinets connected.

Battery average temp (°C)

Average temperature of the battery.

Battery highest temp (°C)

Highest temperature battery has reached.

Battery lowest temp (°C)

Lowest temperature battery has reached.

Output Status Options**L-N voltage (V)**

Line-neutral voltage of output power.

L-N Current (A)

Line-neutral current of output power.

Frequency (Hz)

Frequency of output power.

L-L voltage(V)

Line-line voltage of output power.

Energy (kWh)

Output power

Load Status Options**Sout (kVA)**

Apparent output power.

Pout (kW)

Active output power.

Power Factor

Power factor of output power.

Load percent (%)

Percentage of recent power rated to output power.

4.2.4. Settings Submenu

The settings screen consists of tabs that list UPS settings for configuration and adjusting parameters with tabs for:

- Output
- Battery
- Monitor
- System

NOTE: Do not change parameter settings or reset to factory defaults when powering-off the UPS.

To modify UPS settings:

1. At the main menu, select the Settings icon, and press **Enter**.

Output Parameter Options

Voltage selection

Nominal voltage setting. Set the nominal system voltage to match the input voltage of the UPS.

- 100/173V
- 100/173RVS (L1/L2 reversed)
- 100/200V
- 110/190.5V
- 110/190.5RVS (L1/L2 reversed)
- 110/220V
- 115/199V
- 115/199RVS (L1/L2 reversed)
- 115/230V
- 120/208V (default)
- 120/208RVS (L1/L2 reversed)
- 120/240V

- 125/216.5V
- 125/216.5RVS (L1/L2 reversed)
- 125/250V
- Autodetect (default)

Startup on bypass

Allows the UPS to start-up in bypass mode.

- Enable = Start the UPS in bypass mode
- Disable = Start the UPS in normal mode. (default)

Frequency selection

Selects the frequency of the output.

- Auto, Bypass enabled = Automatically detects frequency of utility/mains power and sets the nominal frequency to match and bypass mode is enabled (default).
- Auto, Bypass disabled = Automatically detects frequency of utility/mains power and sets the nominal frequency to match and bypass mode is disabled.
- 50 Hz, Bypass disable = Bypass mode is disabled and the UPS provides 50-Hz output from any qualified utility/mains power.
- 60 Hz, Bypass disable = Bypass mode is disabled and the UPS provides 60-Hz output from any qualified utility/mains power.

Bypass voltage upper limit

Sets the percentage that the input voltage may be above the selected output voltage setting and remain in Bypass mode.

- +10% (default)
- +15%
- +20%

Bypass voltage lower limit

Sets the percentage that the input voltage may be below the selected output voltage setting and remain in Bypass mode.

- -10% (default)
- -15%
- -20%

Run mode

Selects Normal or ECO operation for the UPS.

- Normal = Connected load is always powered through the UPS inverter. ECO mode is disabled

(default).

- ECO mode = ECO mode is enabled. The UPS inverter is bypassed, and the connected load is powered by utility/mains power within the selected ECO voltage and frequency tolerances.

ECO voltage range

(Option only available when Run mode is set to ECO.) Sets the percentage that the input voltage may be above or below the selected output voltage setting and remain in ECO mode.

- $\pm 5\%$
- $\pm 10\%$ (default)
- $\pm 15\%$

ECO frequency range

(Option only available when Run mode is set to ECO.) Sets the amount that the input frequency (Hz) may be above or below the selected frequency setting and remain in ECO mode.

- $\pm 1\text{Hz}$
- $\pm 2\text{Hz}$
- $\pm 3\text{Hz}$ (default)

ECO requalification time

(Option only available when Run mode is set to ECO.) To ensure the stability of the utility/mains power, this is the length of time that the UPS requires the input voltage and frequency tolerances to be maintained before switching to ECO-mode.

- 1 min (default)
- 5 min
- 15 min
- 30 min

Battery Parameter Options

External battery AH

Sets the amp-hour rating of the external battery. This should only be adjusted when using third-party external batteries with “External battery cabinet group No.” set to 0. It is calculated automatically when using Vertiv EBCs using the setting of “External battery cabinet group No.”.

- 0 - 300 Ah (default of 0)

External battery cabinets

Sets the number of attached external battery cabinets or allows the number of EBCs to be detected automatically with Autodetect. Autodetect is used only for Vertiv EBCs. If more than 6 Vertiv EBCs are connected, autodetect does not function and this must be set manually. For third-party external batteries, set this option to 0 and use “External battery AH” setting above.

- 0 - 10
- Autotest (default)

Low battery time

Sounds an alarm when the selected amount of time remaining for the UPS to operate in Battery mode.

- 2 - 30 minutes (default of 2)

Battery periodic test

The UPS can periodically self-test the battery.

- Enable (default)
- Disable

Battery periodic test interval

Sets the length of time between periodic test.

- 8, 12, 16, 20, or 26 weeks (default is 8)

Battery periodic test weekday

Sets the day of the week that the battery periodic test is performed.

- Sunday - Saturday (Wednesday is default)

Battery periodic test time

Sets the time that the battery periodic test is performed.

- 00:00 - 23:59 (default is 00:00)

Battery reminder (months)

Sets the length of time after the batteries are replaced to generate an alarm to remind the user to replace the batteries.

- Disable (default)
- 1 - 72 months

Dischg protect time

Sets the maximum discharge time for the UPS. The default setting is the maximum allowing the battery to fully discharge. This can be set lower to limit the amount of time the UPS will provide battery protection after which it will shut down. If the discharge time remaining on the battery is lower than the setting value, it will have no effect.

- 1 - 4320 minutes (default of 4320)

Max chg curr

Sets the maximum charge current for the battery. A higher charge current will charge the battery more quickly but can shorten battery life. A lower value will lengthen the battery charge time and can increase battery life. The load is always prioritized and the charge current will be decreased internally if necessary to support the load.

- 0.9 - 13 A (See [Table 7-1 on page 82.](#))

NOTE The maximum setting of this value always shows as 13A on the display however it varies based on internal battery size and the number of EBCs connected. If the value does not save after it is selected, it is too high for the model.

Temp compensation

When enabled, the UPS will adjust the charging voltage of the batteries based on temperature in order to preserve battery life. It will increase the voltage if the UPS is operating in a cold environment. It will decrease the voltage if the UPS is operating in a warm environment.

- Enable (default)
- Disable

Replace battery

Activates newly-installed battery packs after replacement and reset all battery statistics for new battery packs.

- Provides a confirmation window with Yes/No options to confirm replacement of batteries.

Monitor Settings Options

Language

Selects the language of the display, see [Selecting the Display Language](#) on page 62.

- English (default)
- French
- Portuguese
- Spanish
- Chinese
- German
- Japanese
- Russian

Date

Selects the current date for the UPS display, YYYY-MM-DD. See [Setting the Date and Time](#) on page 62.

Time

Select the current time for the UPS display, HH:MM:SS. See [Setting the Date and Time](#) on page 62.

Display orientation

Selects the orientation of the display for use in rack or tower configuration.

- Auto-rotate = Automatically rotates based on the detected orientation of the UPS. (default)
- Horizontal = Screen rotated for rack use.
- Vertical = Screen rotated for tower use.

Audible alarm

If enabled, the UPS will beep when an alarm is generated. If disabled, it will be silent. See [Audible Alarm \(Buzzer\)](#) on [page 78](#).

- Enable (default)
- Disable

Change settings password

Opens the dialog to change the password used to access and update the UPS parameter settings, see [Changing the Password](#) on [page 61](#).

System Parameter Options

Auto restart

Allows the automatic restart of the UPS when input power is restored after a shutdown of the UPS due to battery EOD (end of discharge).

- Enable = The UPS will restart automatically when the input power is restored after EOD. (default)
- Disable = The UPS will not restart automatically

Auto restart delay

Length of time to elapse before an automatic restart after input power is restored.

- 0 - 999 seconds (default 0)

Guaranteed shutdown

Forces a continued shutdown of the UPS after the Low Battery alarm threshold is reached, even if input power is restored during this time. This can be used to ensure connected equipment shuts down completely after receiving a signal to shutdown from an external monitoring device before power is re-applied. This ensures that once the equipment begins to shut down, it is brought down completely before power is applied again.

- Enable
- Disable (default)

Start with no battery

Allows the UPS to start when the battery is not installed or is not functional due to damage. This can be used to turn on the UPS and power the attached load without battery protection when utility power is available but battery backup is not.

- Enable
- Disable (default)

Remote control

Allows the UPS to be controlled remotely via the CLI or RDU101 card.

- Enable (default)
- Disable

Any mode shutdown auto restart enable

Automatically restart the UPS after an “Any mode shutdown” signal is received. When the UPS is shut down via dry-contact inputs 1 or 2, it will restart automatically if this option is enabled.

- Enable
- Disable (default)

Output contact NO/NC

Selects the states of the dry contact outputs 5 and 6.

- Normally open (default)
- Normally closed

Input contact NO/NC

Selects the states of the dry contact inputs 1 and 2.

- Normally open (default)
- Normally closed.

Dry contact 5 (Output)

Selects the output of dry-contact 5:

- Low battery = The contacts switch when the UPS reaches the amount of time left on battery configurable from “Low battery time”. (default)
- On bypass = The contacts switch when the UPS is running in bypass mode
- On battery = The contacts switch when the UPS is running on battery
- UPS fault = The contacts switch when a UPS fault has occurred

Dry contact 6 (Output)

Selects the output of dry contact 6:

- Low battery = The contacts switch when the UPS reaches the amount of time left on battery configurable from “Low battery time”.
- On bypass = The contacts switch when the UPS is running in bypass mode
- On battery = The contacts switch when the UPS is running on battery
- UPS fault = The contacts switch when a UPS fault has occurred. (default)

Dry contact 1 (Input)

Selects the action taken by the UPS when the input of dry-contact 1 is triggered:

- Disable (default)
- Battery mode shutdown = If the UPS is running on batteries and this input is triggered, the UPS shuts down

- Any mode shutdown = If this input is triggered, the UPS shuts down regardless of current operating mode

Dry contact 2 (Input)

Selects the action taken by the UPS when the input of dry-contact 2 is triggered:

- Disable (default)
- Battery mode shutdown = If the UPS is running on batteries and this input is triggered, the UPS shuts down
- Any mode shutdown = If this input is triggered, the UPS shuts down regardless of current operating mode

Sleep mode

Allows the UPS to turn off the output on a weekly schedule. For instance, turn on every Monday at 1:00 and off every Friday at 23:00.

- Enable
- Disable (default)

Power on day of week

Sets the day of week to turn on the UPS. This option is only shown when sleep mode is enabled.

- Sunday-Saturday (default Monday)

Power on time

Sets the time of day to power on the UPS on the selected day. This option is only shown when sleep mode is enabled.

- 00:00 - 23:59 (default 00:00)

Power off day of week

Sets the day of week to turn off the UPS. This option is only shown when sleep mode is enabled.

- Sunday-Saturday (default Friday)

Power off time

Sets the time of day to power off the UPS on the selected day. This option is only shown when sleep mode is enabled.

- 00:00 - 23:59 (default 00:00)

IT system compatibility

When this option is enabled, the “Input phase reversed” and “Input ground lost” alarms are disabled.

- Enable
- Disable (default)

4.2.5. Control Screen

The Control screen offers UPS-control options.

To adjust the UPS controls:

1. At the main menu, select the Control icon, and press **Enter**.
2. Use the arrow buttons to move the cursor to the option, then press **Enter** to select the control.

Figure 4-6 Control Screen

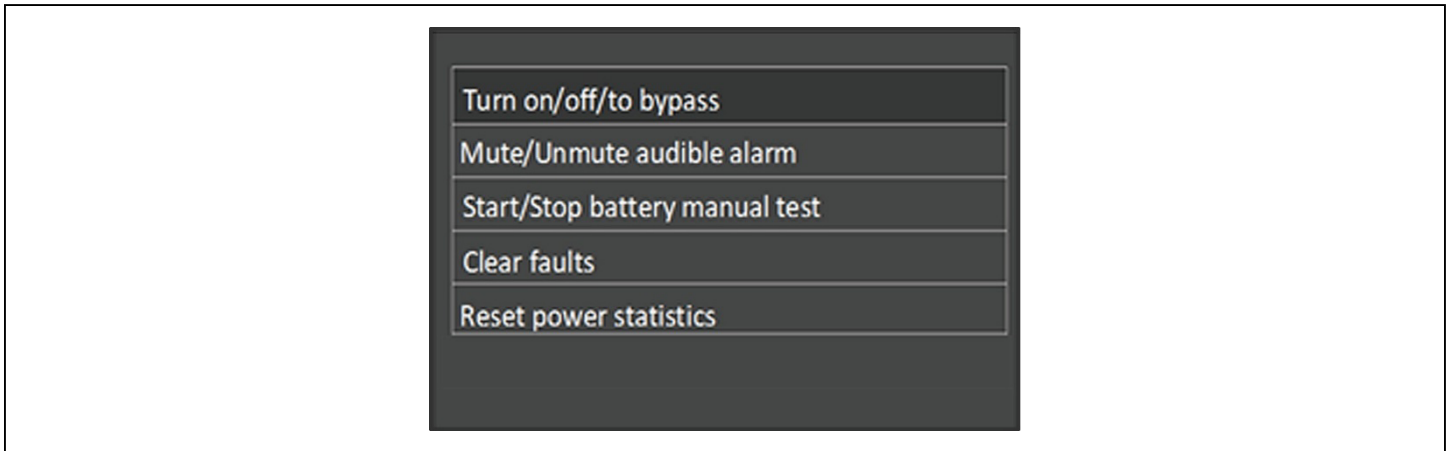

Control Options

Turn on/off/to bypass

Opens the dialog to change operating modes, see [Operating the UPS on page 33](#).

Mute/Unmute audible alarm

Silences or un-silences the audible alarm, see [Silencing the Audible Alarm on page 33](#).

Start/Stop battery manual test

Starts the battery self test manually. If the manual self test is already running, stop the self test.

Clear faults

Clears displayed faults after the issue causing the fault is resolved, see [Table 6-2 on page 79](#), for a description of the faults.

Reset power statistics

Resets the values tracked to calculate the Efficiency graph, see [About Screen on page 58](#).

4.2.6. Log Screen

The Log Screen offers tabs that list the current alarms and the alarm/event history. [Table 4-4](#) below, describes the alarm messages you may see in the logs.

To view the logs:

1. At the main menu, select the Log icon, and press **Enter**.
2. Use the arrow buttons to move the cursor left/right and select a tab, then press **Enter** to display the log for the selected tab.

Figure 4-7 Current and History Log Tabs

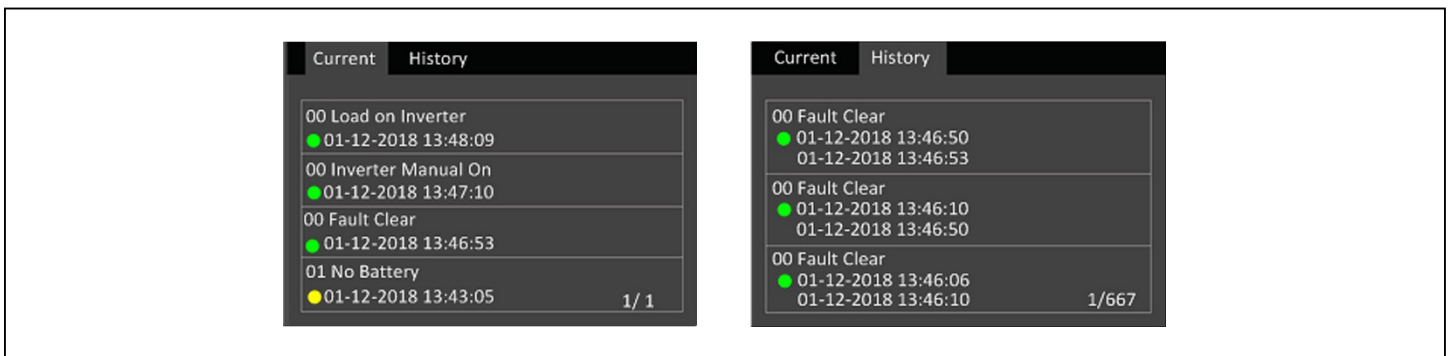

Table 4-4 Alarm Messages

MESSAGE	DESCRIPTION
Aux. power fault	UPS internal auxiliary power voltage fault. Contact Vertiv Technical Support.
Battery cabinet connect abnormal	More than 10 external battery cabinets are connected to the UPS. Disconnect excess battery cabinets.
Battery aged	The battery is old and at the end of its useful life. Replace the battery.
Battery EOD	The battery has reached the end of discharge and mains/utility power is unavailable. Restore the mains power. The UPS will power off if it is not restored.
Battery low pre-warning	This alarm occurs when the battery approaches the EOD. After the pre-warning, the battery capacity allows two minutes discharge at full load. The user can set the time with the Low Battery Time setting in Battery settings from 2 min - 30 min, (2 min by default). This allows for any loads to be shut down before the system powers off if utility power cannot be restored.
Battery mode	The UPS operating in battery mode. The alarm will clear when utility power is restored.
Battery overtemp	Battery ambient temperature too high. Ensure that the battery ambient temperature is not higher than setting value 40 ~ 60 °C (default: 50 °C)
Battery replacement timeout	The system time is past the time set for the batteries to be replaced. If you have disabled the "Batt. note duration" or have no batteries installed, the alarm will not occur.
Battery reversed	The battery positive and negative are reversed. Reconnect the battery and check the battery cable connections.
Battery test fail	The voltage of the battery was low when the periodic or manual self-test was run. Battery replacement is Recommended.
Battery test started	The battery periodic self-test or manual self-test was started. This will display in the log whenever the event occurs.
Battery test stopped	The battery periodic self-test or manual self-test has finished. This will display in the log whenever the event occurs.
Battery to utility transition	The UPS has transferred the load to the mains power from the battery. This will display in the log whenever the event occurs.
Battery voltage abnormal	The battery voltage exceeds the normal range. Check if the battery terminal voltage exceeds the normal range.

Table 4-4 Alarm Message (continued)

MESSAGE	DESCRIPTION
Battery to utility transition	The UPS has transferred the load to the mains power from the battery. This will display in the log whenever the event occurs.
Battery voltage abnormal	The battery voltage exceeds the normal range. Check if the battery terminal voltage exceeds the normal range.
Bypass abnormal	May be caused by bypass voltage and frequency outside of range, bypass power-off and incorrect bypass cables connection. Check that the bypass voltage and frequency are within the setting range. Check the bypass cables connection
Bypass abnormal in ECO mode	May be caused by ECO bypass voltage and frequency outside of range, ECO bypass power-off, and incorrect ECO bypass cables connection. Check that the ECO bypass voltage and frequency are within the setting range. Check the bypass cable connection
Bypass mode	The UPS is on bypass. This will clear when the UPS returns to Normal mode.
Bypass over-current	The load is drawing more current than the UPS is rated to supply in bypass mode. Reduce the load.
Charger fault	The charger output voltage is abnormal, and the charger is off. Contact Vertiv Technical Support.
Communication fail	Internal communication is abnormal. Check that the communication cables are connected correctly.
DC bus abnormal	The inverter is off due to DC bus voltage out of acceptable range. The load will transfer to bypass if the bypass is available because the bus voltage is outside of the acceptable range.
DC/DC fault	The discharger is faulty, because the bus voltage exceeds the range when the discharger starts. Contact Vertiv Technical Support.
EOD turn off	The inverter is off due to EOD. Check the mains power-off state and recover the mains in time
Fan fault	At least one fan is faulty. Check if the fan is blocked or the cable connection is loose.
Faults cleared	The faults have been cleared using Settings > Controls > Clear faults. This will display in the log whenever the event occurs.
Guaranteed shutdown	The battery has finished discharging, then system shuts down because Guaranteed Shutdown is enabled (see Guaranteed shutdown on page 37). This alarm will clear when the UPS is turned on again.
Input abnormal	The rectifier and charger are off due to the mains voltage and frequency exceeding normal range. Check that the rectifier input phase voltage and frequency exceed the normal range or that the mains has power-off
Input ground lost	Check that the PE line is well connected and that the alarm can be cleared at the display.
Input neutral lost	The mains input neutral is not detected. The alarm will clear when the neutral connection has been restored.
Input phase reversed	The mains input line and neutral are reversed. Shut off external input breaker and connect the lines correctly.
Insufficient capacity to start	The UPS is on bypass and is started with a load greater than 105% of the rated capacity. Reduce the load to the rated capacity or below to start the unit.
Inverter fault	The inverter is turned off when the inverter output voltage or current exceed the ranges set. If bypass is available, the UPS will transfer to bypass mode, otherwise the system will power off. Contact Vertiv Technical Support.
Inverter overload	Inverter load capacity is larger than the rated value, overload delay time is up, inverter shuts down. If bypass is available, the system will transfer to the bypass mode, otherwise the system will power off. Check the output load. If overloaded, reduce the load, and the system will transfer to the inverter mode after five seconds with no alarm.
Inverter relay welded	The inverter relay is shorted. Contact Vertiv Technical Support.
Load off due to output short	A short has occurred on the output. Check the output cables and for any equipment that may have shorted.
Load off due to shutdown on battery	The system was shut down in battery mode. This will clear when the system is turned back on.
Manual power- on	The system was turned on via the display panel. This will display in the log whenever the event occurs.

Table 4-4 Alarm Message (continued)

MESSAGE	DESCRIPTION
Manual shutdown	The system was shut down via the display panel. This will display in the log whenever the event occurs.
No battery	No battery detected. Check the battery and battery cable connection(s).
On maintenance bypass	The UPS is operating in maintenance bypass mode. This will display in the log whenever the event occurs.
Operating on inverter	The UPS output is being powered by the inverter. This will display in the log whenever the event occurs.
Output disabled	The system is in standby state, and the dry contact shutdown is enabled. Check if the shutdown dry contact is enabled.
Output off due to bypass abnormal	The bypass voltage or frequency is outside the acceptable range, and the bypass is in stand-by mode. Check that the input is normal.
Output off due to overload & bypass abnormal	The output is off due to an overload of the UPS output, and the bypass voltage or frequency is outside the acceptable range. Check that the input is normal.
Output off, voltage is not zero	This occurs when the output is off and the system detects that there is still voltage on the output. Check output equipment for backfeeds or contact Vertiv Technical Support.
Output pending	Remote shutdown has been initiated, and the system will turn off shortly.
Output short	A short has occurred on the output. Check the output cables and for any equipment that may have shorted.
Rectifier fault	The rectifier is off because the bus voltage is out of the acceptable range when the rectifier starts. Contact Vertiv Technical Support.
Rectifier overload	The output power is larger than the rectifier overload point. Check that the input voltage meets the output load, mains input 176 V ~ 100 V, the load 100% ~ 50% linear derating.
Remote power- on	The UPS was powered on remotely. This will display in the log whenever the event occurs
Remote shut- off	The UPS was powered off remotely. This will display in the log whenever the event occurs.
Remote shutdown	Any mode shutdown was initiated by the dry contact input. This will display in the log whenever the event occurs.
REPO	Shutdown caused by the REPO terminal Normally-Closed contact input opening. This will display in the log whenever the event occurs.
Restore factory defaults	On the Maintenance page, "Restore Factory Defaults" has been set while the UPS is in the stand-by state. This will return settings to their factory settings.
Shutdown due to over temp	During the UPS operation, the system checks if the heat sink temperature exceeds the setting range. If an overtemperature occurs, check if : 1. The ambient temperature is too high. 2. Dust is blocking any of the UPS vents. 3. A fan fault has occurred.
System over temp	The internal heat-sink temperature is too high, and the inverter is off. The alarm can only be silenced if the heat-sink temperature is lower than the alarm setting. The system can automatically start after overtemperature fault is corrected. If an overtemperature occurs, check if : 1. The ambient temperature is too high. 2. Dust is blocking any of the UPS vents. 3. A fan fault has occurred.
Turn on fail	The UPS does not start because there is no mains/utility power or it is outside of the range of the voltage required to supply the full load. Check the AC input power.
UPS has no output	Both Inverter and Bypass are not supplying power due to the UPS output being turned off remotely or via the LCD, or are unavailable due to no input power or input power out of range. Check that UPS is on and input power is available.

4.2.7. About Screen

The About screen offers tabs that list information about the product.

- Product tab—shows UPS identification information, firmware versions, and information about the communication card (when the card is installed).
- Efficiency tab—shows curve of the efficiency of your UPS model vs the load. The efficiency at the current load is shown to the right of the graph.
- Battery age tab—shows the curve of the state-of-health (SOH) percentage of the installed battery over time. The SOH is measurement of the installed battery's condition and ability to deliver the specified performance compared to a fresh battery. During the lifetime of a battery, its health will deteriorate gradually due to irreversible physical and chemical changes which take place with usage and with age until eventually the battery is no longer usable. The UPS calculates one value per week and plots it on the graph. The values are based on battery temperature, age, and the total amount of energy discharged from the battery that week. With use over time, this percentage will decrease until the "Battery Aged" alarm is generated at 25%. It is recommended to replace the battery at or before this time.

To view the product, efficiency, and battery-age information:

1. At the main menu, select the About icon, and press **Enter**.
2. Use the arrow buttons to move the cursor left/right and select a tab, then press **Enter** to display the information for the selected tab.

Figure 4-8 About Screen Tabs

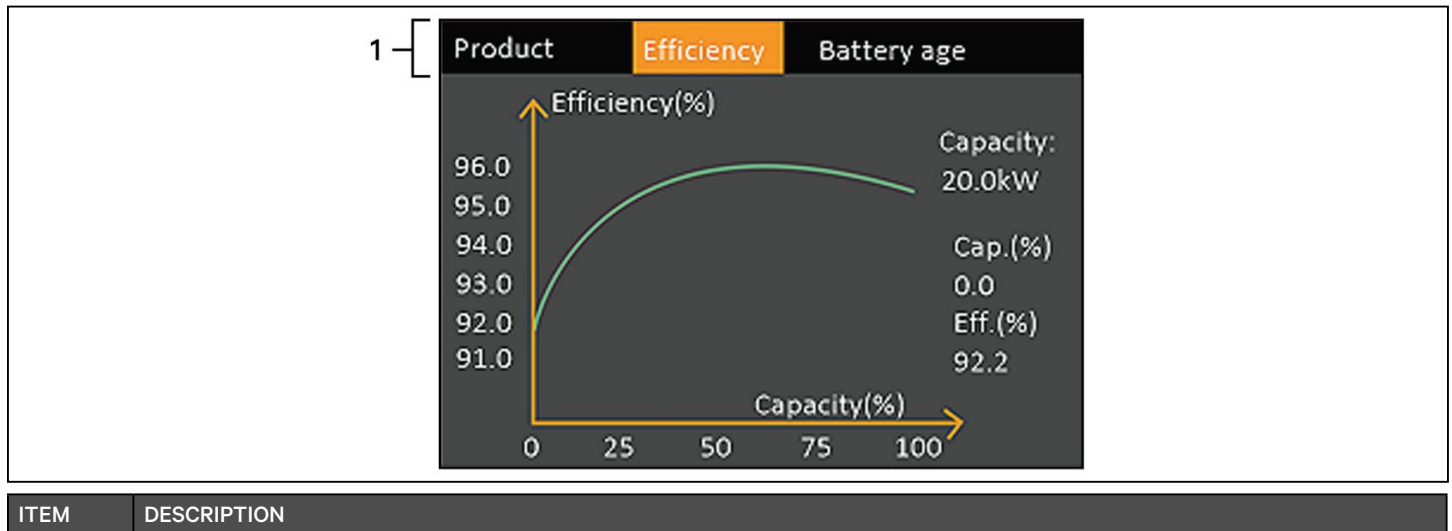

1	About screen tabs with Efficiency tab selected. Note: The tab shown in the figure is an example of the graph and does not represent the actual capacity values for your UPS model.
---	--

Product Information

Product Type

UPS model number.

Serial number

UPS serial number.

Time since startup

Elapsed time since start-up of the UPS.

Boot FW version

Version of MCU boot firmware on the monitor board.

Monitor FW version

Version of MCU application firmware on the monitor board.

DSP FW version

Version of DSP firmware on the UPS power-module.

MAC address

Shows the MAC address of the RDU101 card. This is only shown when the RDU101 card is installed.

IPv4 address

Shows the IPv4 address of the RDU101 card. This is only shown when the RDU101 card is installed.

Subnet mask

Shows the subnet mask of the RDU101 card. This is only shown when the RDU101 card is installed.

Gateway address

Shows the gateway address of the RDU101 card. This is only shown when the RDU101 card is installed.

Efficiency Tab

Capacity

This shows the maximum capacity of your UPS model.

Cap. (%)

This shows the percentage of the maximum capacity your UPS is currently using.

Eff. (%)

This shows the efficiency the UPS is currently operating at based on the Cap. (%) value.

Battery Age

This page also displays the following values:

Battery recommended replacement date

This shows the date that it is recommend to replace the battery. It is 5 years from the time the battery was installed.

SOH (%)

This shows the current SOH percentage.

4.3. Editing Display and Operation Settings

You may adjust the display settings and UPS configuration via the LCD. The display and operation settings are password protected. The default password is 111111 (six ones).

NOTE: We recommend that you change the password to protect your system and equipment and record the new password and store it in an accessible location for later retrieval. See [Changing the Password on the next page](#).

To enter the password:

1. Press the up-arrow button to change the digit, then press the down-arrow button to move to the next digit.
2. Repeat to select each digit, and press **Enter** to submit the password.

Figure 4-9 Password Prompt

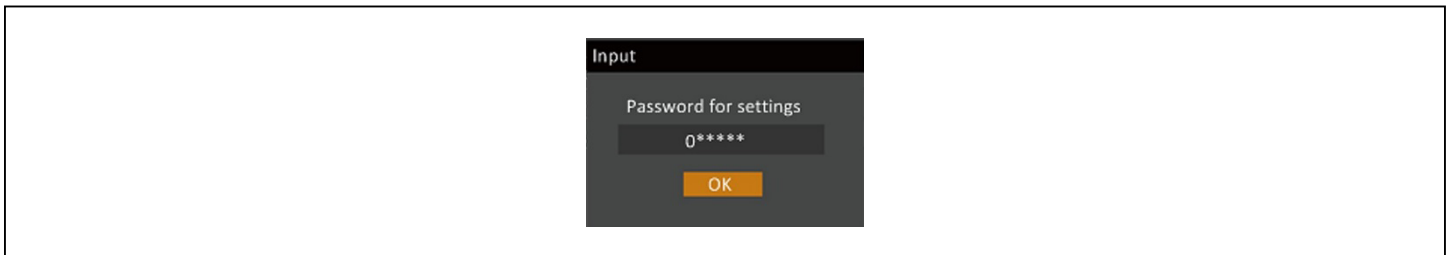

4.3.1. Settings Prompts

While using the operation and display panel, prompts display to alert you to specific conditions or require confirmation of commands or settings. [Table 4-5](#) lists the prompts and their meaning.

Table 4-5 Display Prompts and Meanings

PROMPT	MEANING
Cannot set this online, please shut down output	Appears when changing important output settings (output voltage, output frequency, output phase No.).
Incorrect password, please input again	Appears when the Settings password is input incorrectly.
Operation failed, condition is not met	Appears when attempting to execute a operation for which the required conditions are not met.
Password changed OK	Appears upon successful change of the Settings password.
Fail to change password, please try again	Appears when attempting to change the Settings password but the new and confirmation passwords do not match.
The time cannot be earlier than system time	Appears when attempting to set the time of 'Turn on delay' or 'Turn off delay' earlier than the current system time.
Turn on failed, condition is not met	Appears when proper conditions are not met for UPS power-on. Applies when using the power button or when execute the command of 'Turn on/Turn off/to Bypass' on the LCD panel 'Control' page).
Cannot set this on line, please unplug REPO	Appears when attempting to change the output phase number while the output is connected.

4.3.2. Changing the Password

The default password is 111111 (six ones). You must use the current password to change the password.

NOTE: We recommend that you change the password from the default to protect your system and equipment. Record the new password and store it in an accessible location for later retrieval.

1. At the main menu, select the Settings icon, and press **Enter**.
2. At the password prompt, use the up-arrow to select the first digit, press the down-arrow to move to the next digit, repeat for each digit, then press Enter to access the settings.
3. Use the arrow buttons to select the Monitor tab, then press **Enter**.
4. Use the down arrow to highlight *Change Settings Password*, press **Enter**, and re-enter the current password. The Input new password dialog opens, see [Figure 4-10](#) on the next page.
5. Enter the new password, then confirm the new password.
A confirmation dialog opens to indicate a successful password change.
6. Press **ESC** to return to the settings or main menu.

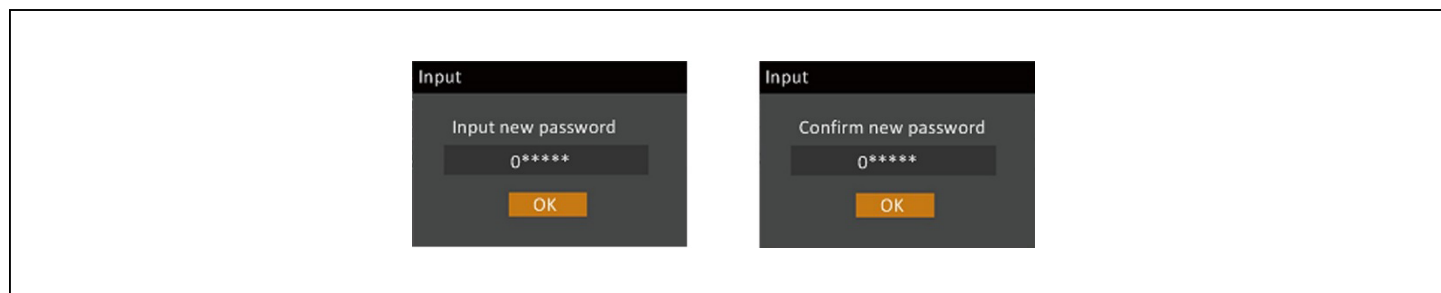
Figure 4-10 New and Confirm Password dialogs

4.3.3. Selecting the Display Language

The LCD is multilingual. The available languages are English, French, Portuguese, Spanish, Chinese, German, Japanese, and Russian.

To change the language:

1. At the main menu, select the Settings icon, and press **Enter**.
2. At the password prompt, use the up-arrow to select the first digit, press the down-arrow to move to the next digit, repeat for each digit, then press **Enter** to access the settings.
3. Use the arrow buttons to select the Monitor tab, then press **Enter**.
4. Use the down arrow to highlight *Language*, then press **Enter**.
5. Use the up/down arrows to select the language, then press **Enter**.
All the LCD elements display in the selected language.

4.3.4. Setting the Date and Time

To adjust the date and time:

1. At the main menu, select the Settings icon, and press **Enter**.
2. At the password prompt, use the up-arrow to select the first digit, press the down-arrow to move to the next digit, repeat for each digit, then press **Enter** to access the settings.
3. Use the arrow buttons to select the Monitor tab, then press **Enter**.
4. Use the down arrow to highlight *Date* or *Time*, then press **Enter**.
5. Use the up/down arrows to select the date/time, then press **Enter** to confirm.
6. Use the down arrow to select the digit to change and the up arrow to select the correct digit. Repeat as needed to set each digit.

Chapter 5: Maintenance



WARNING! Risk of electric shock

Can cause equipment damage, injury and death. A battery can present a risk of electrical shock and high short-circuit current.

Observe the following precautions when working on batteries:

- Remove watches, rings and other metal objects.
- Use tools with insulated handles.
- Wear rubber gloves and boots.
- Do not lay tools or metal parts on top of batteries.
- Disconnect charging source prior to connecting or disconnecting battery terminals.
- If the battery kit is damaged in any way or shows signs of leakage, contact your Vertiv representative immediately.
- Handle, transport, and recycle batteries in accordance with local regulations.
- Determine if the battery is inadvertently grounded. If it is inadvertently grounded, remove the source of the ground. Contact with any part of a grounded battery can result in electrical shock. The likelihood of such shock will be reduced if grounds are removed during installation and maintenance.

5.1. Replacing Batteries



WARNING! Risk of electric shock

Can cause injury or death. Disconnect all local and remote electric power supplies before working with the UPS. Ensure that the unit is shut down and power has been disconnected before beginning any maintenance.



WARNING! Risk of electric shock and explosion

Can cause equipment damage, injury and death. Do not dispose of the battery in a fire. The battery may explode. Do not open or damage the battery. Released electrolyte is toxic and is harmful to skin and eyes. If electrolyte comes into contact with the skin, wash the affected area immediately with plenty of clean water and get medical attention.



WARNING! Risk of electric shock

Can cause equipment damage, injury and death. A battery can present a risk of electrical shock and high short-circuit current.



WARNING! Risk of explosion

Can cause equipment damage, injury and death. A battery can explode if the battery is replaced by an incorrect type. Dispose of used batteries according to the instructions included with the battery-pack.

Read all safety cautions before proceeding. A trained user can replace the internal battery pack when the UPS is in a restricted access location (such as a rack or server closet). To obtain the appropriate replacement battery pack(s), refer to [Table 5-1](#) below, and contact your local dealer or Vertiv representative.

Table 5-1 Replacement Battery-pack Model Numbers

UPS MODEL NUMBER	BATTERY PACK MODEL NUMBER	QUANTITY REQUIRED
GXT5-5000MVRT4UXLN	GXT5-144VBATKIT	1
GXT5-6000MVRT4UXLN	GXT5-144VBATKIT	
GXT5-8000MVRT6UXLN	GXT5-288VBATKIT	
GXT5-10KMVRT6UXLN	GXT5-288VBATKIT	
GXT5-15KMVRT11UXLN	GXT5-288VBATKIT	2
GXT5-20KMVRT11UXLN	GXT5-288VBATKIT	

To replace a battery pack:

NOTE: The internal battery pack is hot-swappable. However, you must exercise caution because; during this procedure, the load is unprotected from disturbances and power outages. Do not replace the battery while the UPS is operating in Battery Mode. This will result in a loss of output power and will drop the connected load.

1. Press the button on the left-front of the UPS front panel, and pull the panel open, then, loosen and remove the screw from the battery door, see [Figure 5-1](#) on the next page.
2. Lay the battery door and screw aside for reassembly.
3. Grasp the battery handle, and pull out the battery pack, see [Figure 5-1](#) on the next page.
4. Unpack the replacement battery pack, taking care not to damage the packaging to re-use when disposing of the old battery.
5. Compare the new and old battery pack to make sure they are the same type and model. If so, proceed with step 6. If they are different, stop and contact your Vertiv representative, or Technical Support, <http://www.Vertiv.com/en-us/support/>.
6. Line-up and slowly push-in each replacement battery pack. The battery is fully-inserted if the battery door fits flush against the UPS.
7. Re-attach the battery door with the screw, and replace the front cover.
8. Activate the new battery pack(s) using the operating/display panel:

NOTE: The display menus and functions are described in [Operation and Display Panel on page 37](#).

- From the main menu, select *Settings*, then the Monitoring tab and verify that the date and time are correct. If the date or time need correction, see [Setting the Date and Time on page 62](#).
- Select the *Battery* tab, use the arrows to select Replace Battery, and press Enter. The replaced battery packs are activated.
- Use **ESC** to return to the main display.

Figure 5-1 Replacing the Battery Pack

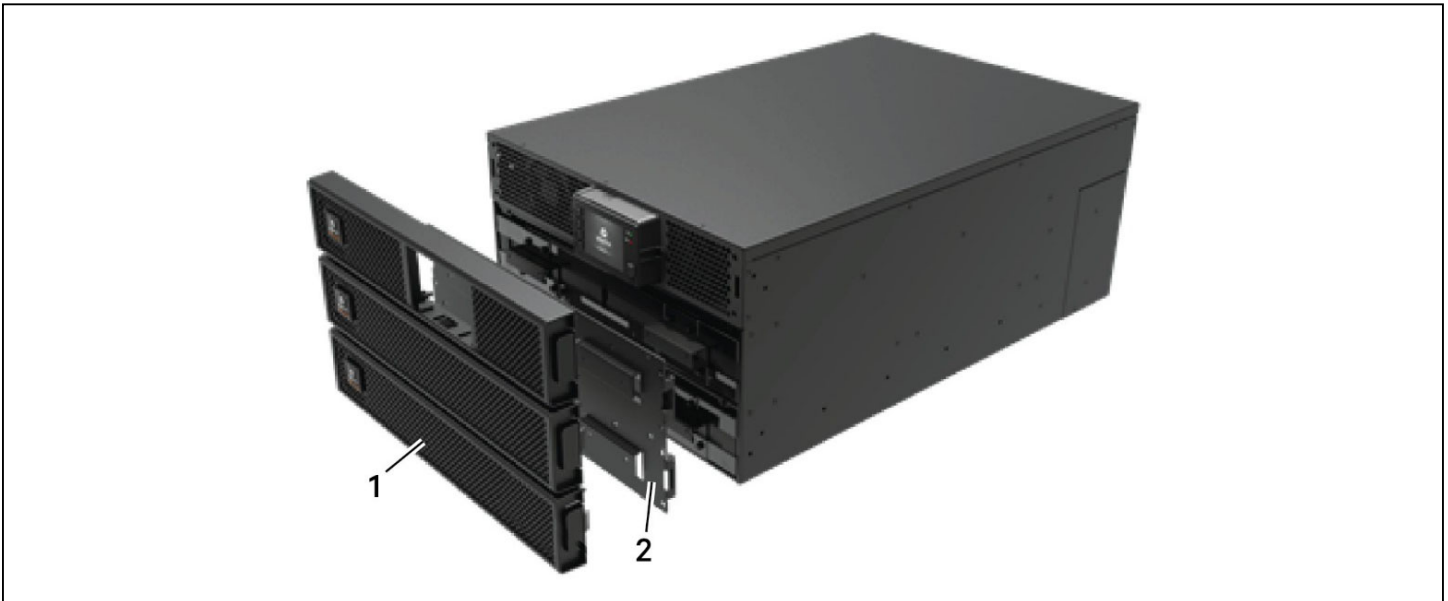

ITEM	DESCRIPTION
1	Front panel
2	Battery door

5.2. Charging Batteries

The batteries are valve-regulated, non-spillable, lead acid and should be kept charged to attain their design life. The UPS charges the batteries continuously when it is connected to the utility input power.

If the UPS will be stored for a long time, We recommend connecting the UPS to input power for at least 24 hours every 4 to 6 months to ensure full recharge of the batteries.

5.3. Checking UPS Operation

NOTE: Operation-check procedures may interrupt power supply to the connected load.

We recommend checking the UPS operation once every 6 months. Ensure that output power loss to the connected load will not cause data loss or other errors before conducting the check.

1. Press the **Power** button to check the indicators and display function.
2. Check for alarm or fault indicators on the operation/display panel.
3. Make sure that there are no audible or silenced alarms.
4. Select the Setting menu, and look at the log for alarm and fault history.

5. Check the operating mode for Normal mode. If the UPS is operating in Bypass mode, contact Vertiv Technical Support.
6. Check to see if batteries are discharging (operating in Battery mode) and utility power is normal. If so, contact Vertiv Technical Support.

5.4. Cleaning the UPS



WARNING! Risk of electric shock

Can cause injury or death. Disconnect all local and remote electric power supplies before working with the UPS. Ensure that the unit is shut down and power has been disconnected before beginning any maintenance.

The UPS requires no internal cleaning. If the outside of the UPS becomes dusty, wipe with a dry cloth. Do not use liquid or aerosol cleaners. Do not insert any objects into the ventilation holes or other openings in the UPS.

5.5. Replacing a POD

Use the following procedures to remove/install a power-output distribution box on the UPS.



WARNING! Risk of electric shock

Can cause injury or death. Disconnect all local and remote electric power supplies before working with the UPS. Ensure that the unit is shut down and power has been disconnected before beginning any maintenance.

NOTE: Do not operate the UPS with the POD removed. To shut off all power to the POD and to the load, utility input power must be disconnected.

1. Transfer the connected equipment to bypass mode.
 - a. Loosen the upper captive screw over the maintenance bypass breaker, see [Figure 5-2](#) on the next page.
 - b. Lift the maintenance-bypass breaker cover up, and tighten the lower captive screw.
2. Confirm that the UPS is operating in bypass mode. If not, then manually transfer the connected equipment to bypass as follows:
 - a. From the main menu select CONTROL, then press **Enter**.
 - b. Select Turn on/off/to bypass and press **Enter**.
 - c. Select Turn to bypass and press **Enter**.

NOTE: The load is unprotected from disturbances in the power supply while the UPS is on bypass.

3. Turn the maintenance-bypass breaker On.
4. Wait 1 minute if the UPS is working on battery mode, then confirm that the UPS is turned-off.
5. Turn the output and input breakers Off. On 8-kVA and 10-kVA models, also turn off the bypass breaker.
6. On 5-kVA models, loosen the remaining captive screws until the POD releases.

– or –

On 8- and 10-kVA models, remove the 2 screws from the top of the POD, see [Figure 5-3](#) on the next page.

7. Remove the POD and set it aside.

NOTE: The captive screws and maintenance-bypass breaker cover is similar for all models. [Figure 5-2](#) below, shows an example on the 5-kVA/6-kVA model.

Figure 5-2 Maintenance-bypass Breaker Cover and Captive Screws

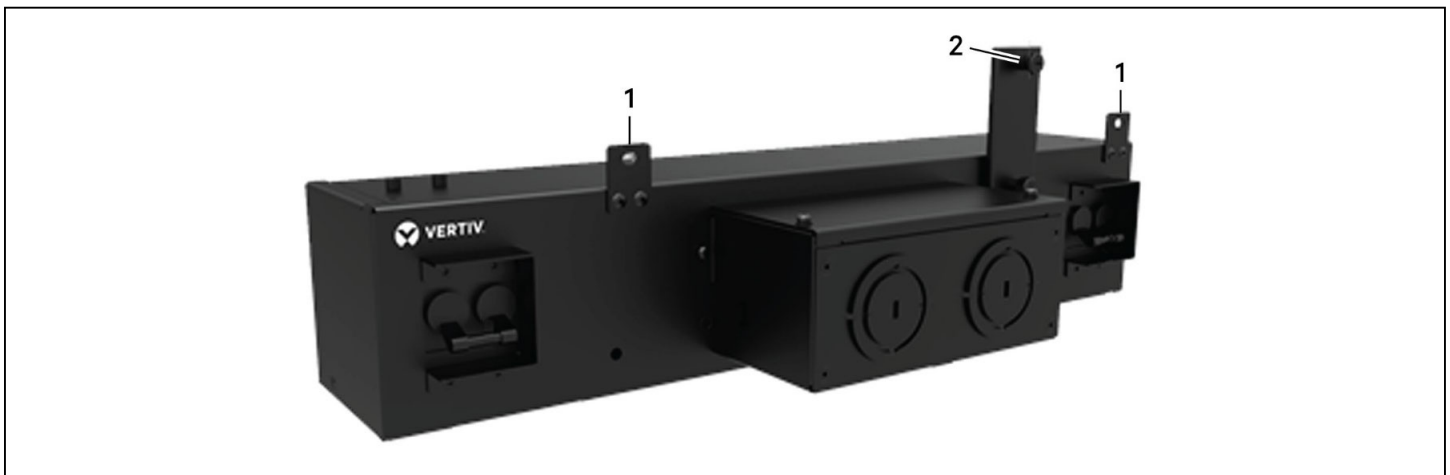

ITEM	DESCRIPTION
1	Captive screws for POD
2	Maintenance-bypass breaker

Figure 5-3 Maintenance-bypass Breaker Cover and Captive Screws

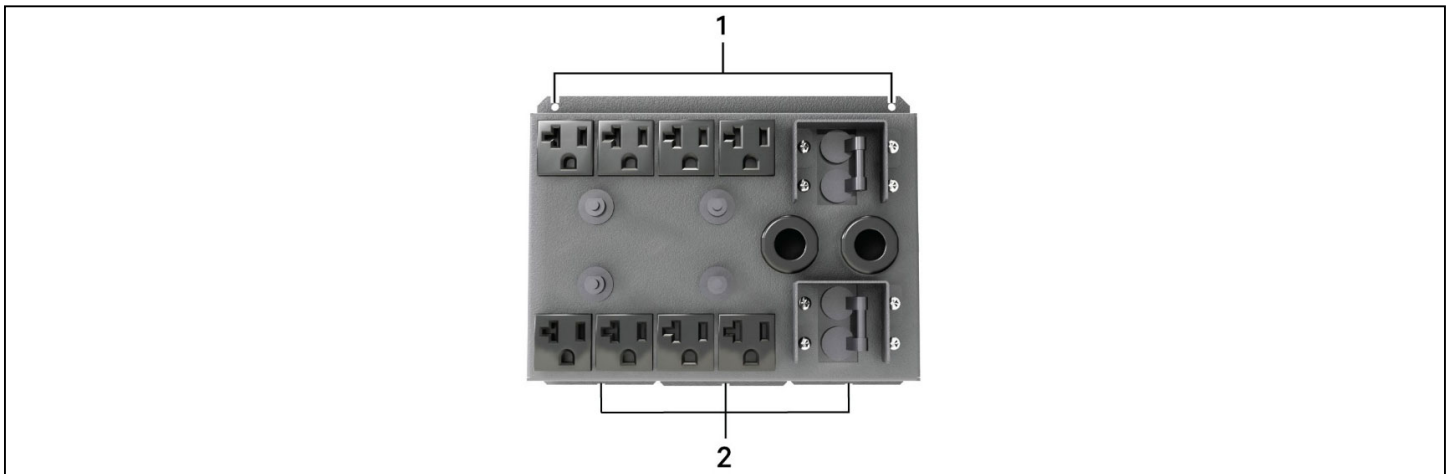

ITEM	DESCRIPTION
1	Fixing screws
2	Tabs

8. Align the tabs on the bottom of the replacement POD with the slots on the UPS, and press the POD onto the UPS.
9. Secure the POD to the UPS using two screws.
10. Make sure the maintenance-bypass switch is in the open, “OFF,” position and that the guard is secured in place.

NOTE: The maintenance-bypass breaker interlock bracket must be installed behind the captive screw, and the screw must be tightened for the UPS to operate in Normal mode.

11. Make sure the input breaker supplying power to the UPS is closed, “ON,” the input breaker on the rear of the UPS is closed, “ON,” and the output breakers are “OFF.”
12. Confirm that the UPS is operating in bypass mode. If not, then manually transfer the connected equipment to bypass as follows:
 - a. From the main menu select CONTROL, then press **Enter**.
 - b. Select Turn on/off/to bypass and press **Enter**.
 - c. Select Turn to bypass and press **Enter**.
13. Turn the output breakers “ON.”
14. Power-on the UPS by pressing and holding the power button on the operation and display panel until the confirmation dialog appears. Use the Up/ Down arrows to select YES, then press **Enter**.

5.6. Firmware Updates

The UPS has two firmware components:

- DSP is the firmware for the power module.
- MCU is the firmware for the display panel.

Both may be updated through a connection the UPS, using CLI and the R232 port or, if the UPS includes the IntelliSlot RDU101 card, using the RJ-45 port on the card.

The latest firmware is available for download from the GXT5 product page at www.Vertiv.com. Refer to [Table 5-2](#) below, and make sure you have the correct files for the update.

Table 5-2 Upgrade File Names by UPS Model

UPS MODEL NUMBER	DSP FIRMWARE FILENAME	MCU FIRMWARE FILENAME
GXT5-5000MVRT4UXLN GXT5-6000MVRT4UXLN GXT5-8000MVRT6UXLN GXT5-10KMVRT6UXLN	GXT5_Small_5k-10k_208_P***.bin	GXT5_M***.bin
GXT5-15KMVRT11UXLN GXT5-20KMVRT11UXLN	GXT5_Small_15k-20k_208_D***.bin	
For DSP update files: <ul style="list-style-type: none">• “P” represents the power module. The number following “P” is the version of the power module.• “D” represents the rectifier and inverter module. The number following “D” is the version of the rectifier and inverter module.• “K” is included after the version for the DSP kernel upgrade file, for example: GXT5_Micro_0.5k-3k_P***K.bin) For MCU update files: “M” represents the MCU module. The number following “M” represents the MCU software version.		

5.6.1. Updating Firmware with RDU101 Card Connection

If your UPS has an IntelliSlot RDU101 communication card installed (optional on some models), you can update firmware with a computer connected to the same network as the card.

NOTE: The RDU101 card is password protected. Be sure to obtain the user name and password from an administrator. The name and password may have been changed from the default.

NOTE: For detailed operating instructions for the card, refer to the Liebert® IntelliSlot™ RDU101 Communications Card Installer/User Guide, available at www.Vertiv.com.

Updating MCU Firmware via RDU101

NOTE: Do not update firmware while the UPS is on Battery mode.

1. Connect a network cable to the RJ-45 Ethernet port of the RDU101 card. For the card/connection location, refer to the appropriate rear-panel description for your UPS model in [Rear Panels](#) on [page 5](#).
2. On a computer connected to the same network as the RDU101, open a browser window and enter the IP

address of the RDU101 card in the address bar.

You can get the card's IP address from the display panel. Select the About menu then the Product tab, and locate IPv4 address.

NOTE: We recommend using the Google Chrome browser.

3. Upload the update file using the card's user interface, see [Figure 5-4](#) below.
 - a. Select the "GXT5" tab, then the File Transfer folder in the tab-menu pane on the left-hand side of the page.
 - b. On the file-transfer page, click Choose File, and select the MCU upgrade file, then click Transfer file.
 - c. Enter the Username and Password, then click Login.

The factory-defaults:

Username : Liebert (case-sensitive)

Password: Liebert (case-sensitive)

NOTE: The name and password may have been changed from the default. Be sure to obtain the username and password from an administrator.

The status of the transfer displays in the File Transfer Status section. After about 2 minutes, the UPS restarts and the web page refreshes.

NOTE: The transfer process takes about 2 minutes. Do not leave or close the page until the status is "Update Complete."

- d. You can check the firmware version, select the System folder in the tab-menu pane on the left-hand side of the page, and check the Firmware Version field, see [Figure 5-5](#) on the next page.

Figure 5-4 File Transfer on the RDU101 User Interface

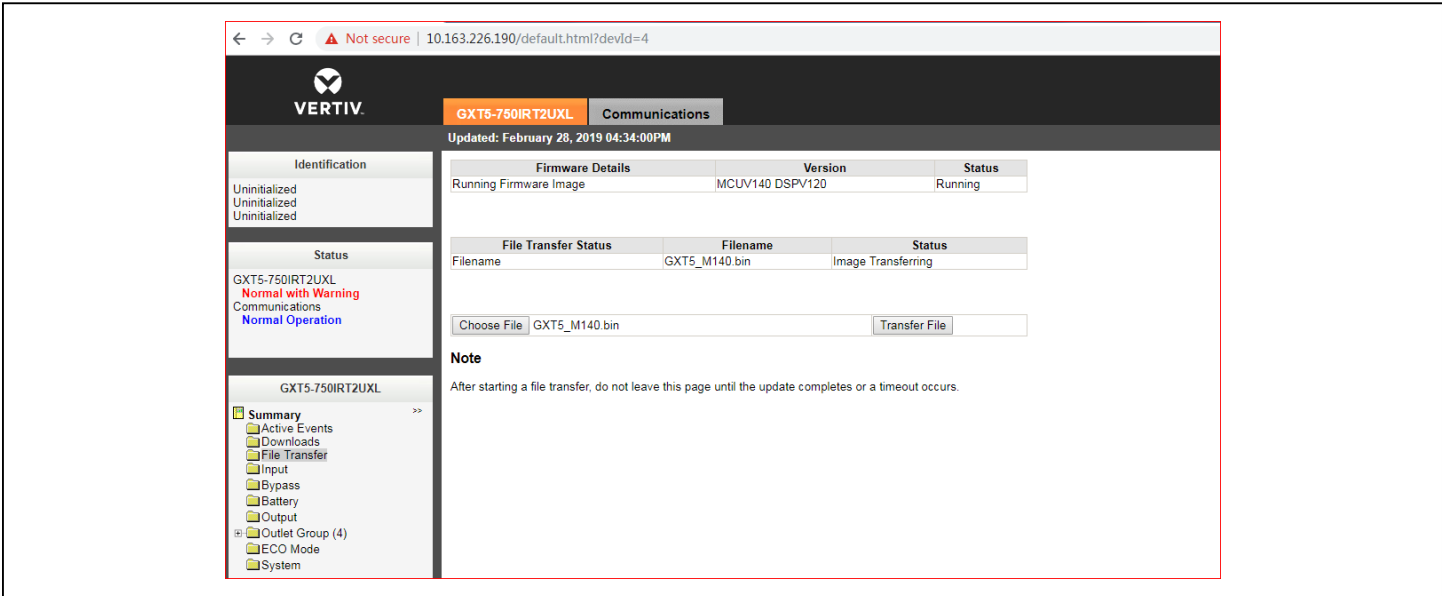

ITEM	DESCRIPTION
1	"UPS" tab, typically the UPS model number
2	File Transfer folder
3	Choose File button
4	Transfer File button
5	Status of file transfer

Figure 5-5 Firmware Version on the RDU101 User Interface

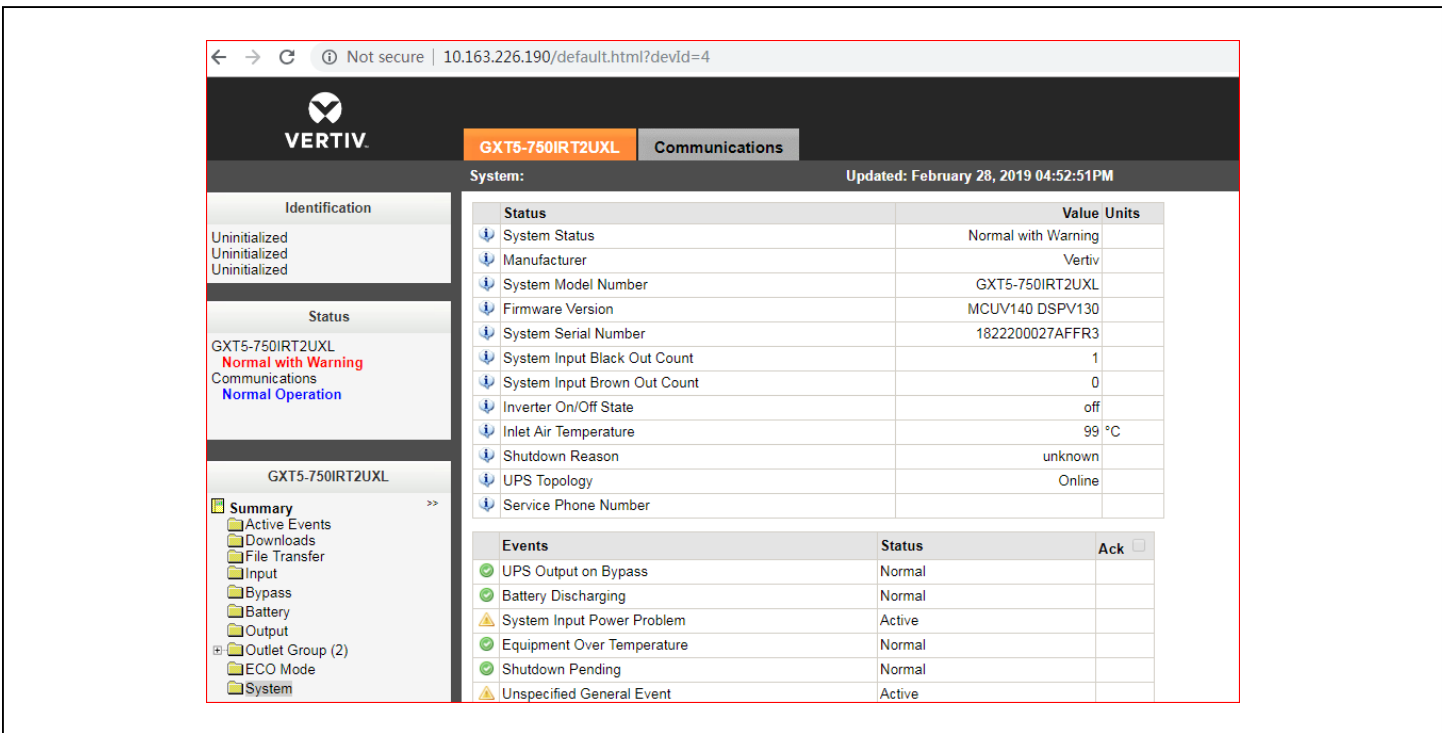

5.7. Updating DSP Firmware via RDU101

NOTE: Only update the DSP firmware while the UPS is in Stand-by mode. The REPO terminal of the UPS must be un-plugged. When the REPO terminal is unplugged the load will lose power. Do not update firmware while the UPS is on Battery mode.

1. Disconnect the REPO terminal from the rear panel of the UPS, see [Figure 5-6](#) on the next page.

NOTE: If updating from DSP FW version V150 or later it is not necessary to disconnect the REPO terminal. The UPS can remain on with the load supported via internal bypass. Check to ensure that utility power is stable before updating. If utility power is lost during the upgrade procedure, there is a chance that the load will be dropped. In the event that this happens, the firmware upgrade procedure may be started again once utility power is restored.

Figure 5-6 REPO Terminal



2. Connect a network cable to the RJ-45 Ethernet port of the RDU101 card. For the card/connection location, refer to the appropriate rear-panel description for your UPS model in [Rear Panels](#) on [page 5](#).
3. On a computer connected to the same network as the RDU101 open a browser window and enter the IP address of the RDU101 card in the address bar.

You can get the card's IP address from the display panel. Select the About menu then the Product tab, and locate IPv4 address.

NOTE: We recommend using the Google Chrome browser.

4. Upload the update file using the card's user interface, see [Figure 5-7](#) on the next page.
 - a. Select the "GXT5" tab, then the File Transfer folder in the tab-menu pane on the left-hand side of the page.
 - b. On the file-transfer page, click Choose File, and select the DSP upgrade file, then click Transfer file.
 - c. Enter the Username and Password, then click Login.

The factory-defaults:

Username : Liebert (case-sensitive)

Password: Liebert (case-sensitive)

NOTE: The name and password may have been changed from the default. Be sure to obtain the user name and password from an administrator.

The status of the transfer displays in the File Transfer Status section. After about 2 minutes, the UPS restarts and the web page refreshes.

NOTE: The transfer process takes about 2 minutes. Do not leave or close the page until the status is "Update Complete."

d. You can check the firmware version, select the System folder in the tab-menu pane on the left-hand side of the page, and check the Firmware Version field, see [Figure 5-8](#).

Figure 5-7 File Transfer on the RDU101 User Interface

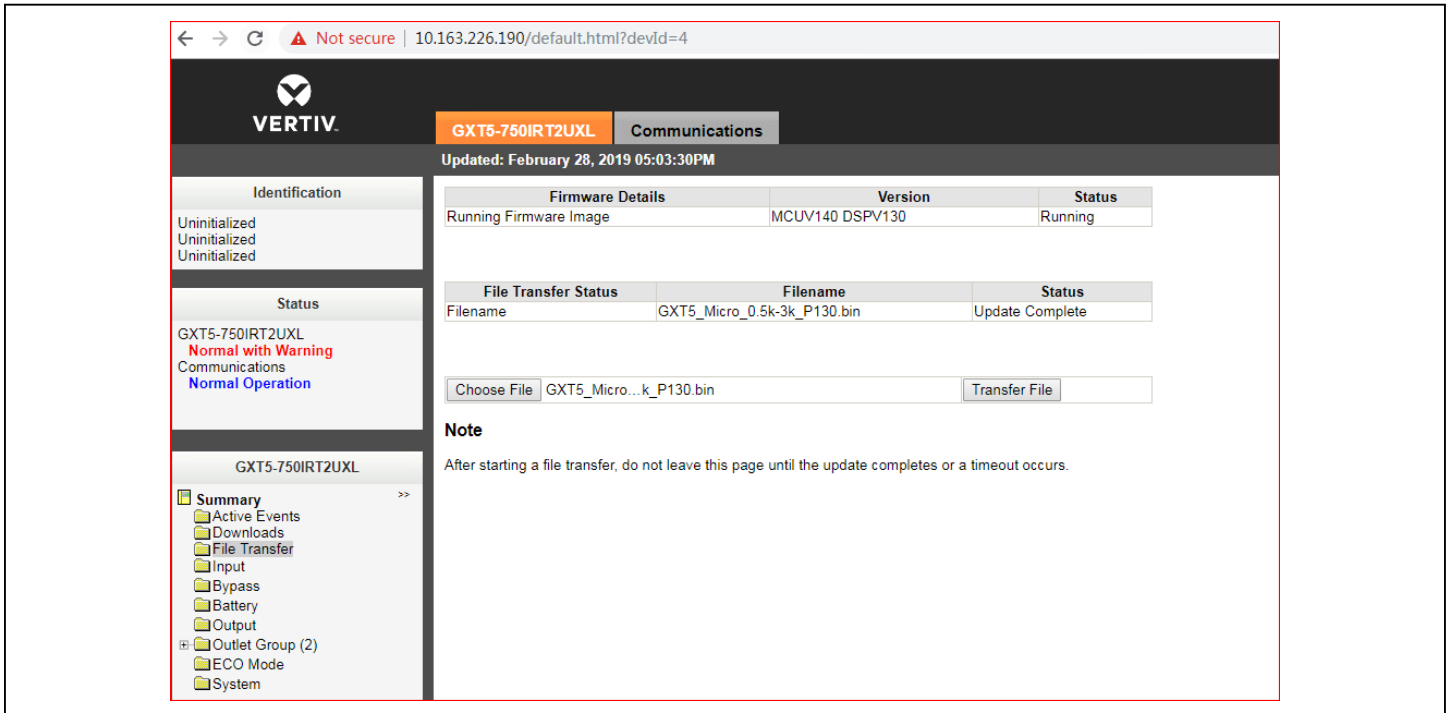
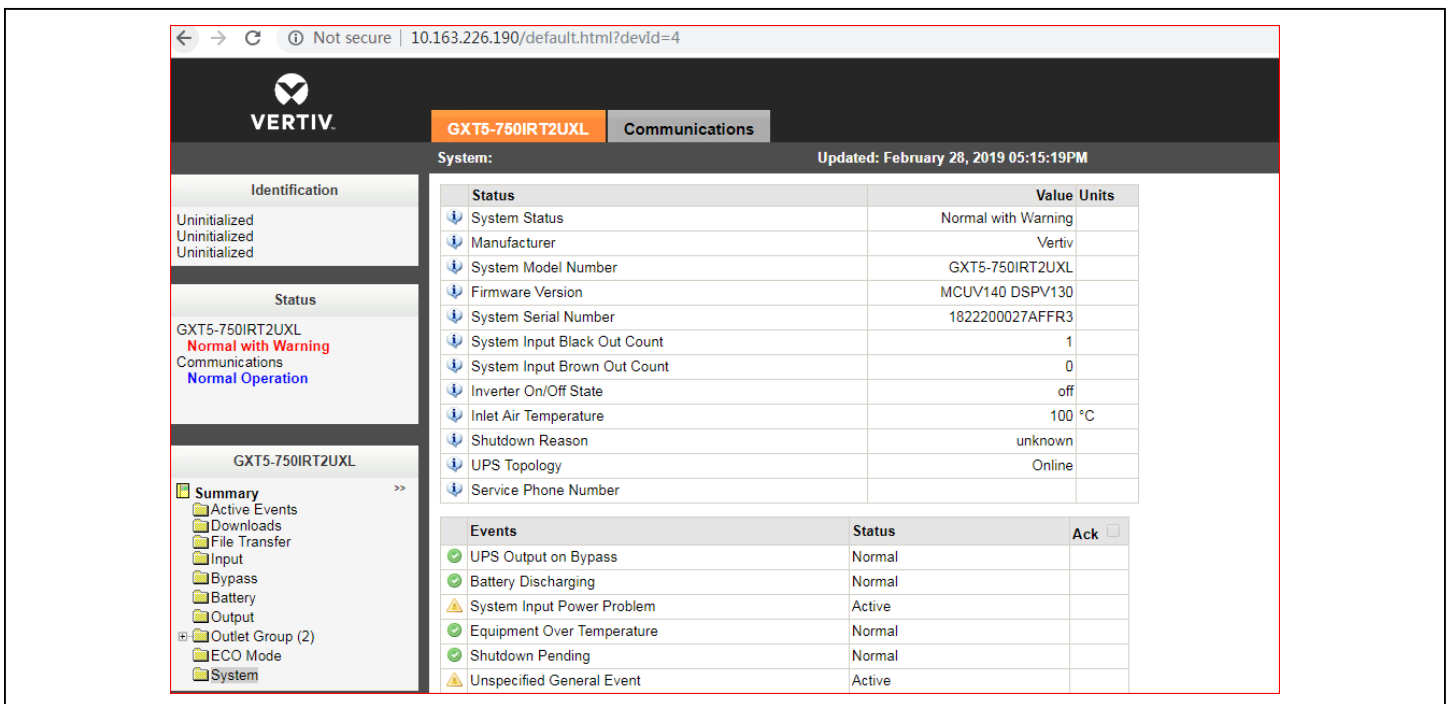

Figure 5-8 Firmware Version on the RDU101 User Interface



This page is intentionally left blank.

Chapter 6: Troubleshooting

This section indicates various UPS symptoms you may encounter and provides a troubleshooting guide in the event the UPS develops a problem. Use the following information to determine whether external factors caused the problem and how to remedy the situation.

6.1. Symptoms that Require Troubleshooting

The following symptoms indicate the UPS is malfunctioning:

- The relative indicators illuminate, indicating the UPS has detected a problem.
- An alarm buzzer sounds, alerting the user that the UPS requires attention.

6.2. Audible Alarm (Buzzer)

An audible alarm accompanies various events during UPS operations. [Table 6-1](#) below, describes the sounds and their meaning. To silence an alarm, see [Silencing the Audible Alarm on page 33](#).

Table 6-1 Audible-alarm Descriptions

SOUND	INDICATES
Continuous beep	Generated when a UPS fault appears, such as a fuse or hardware failure.
One beep every 0.5 seconds	Generated when a UPS critical alarm appears, such as on inverter overload.
One beep every 1 second	Generated when a UPS critical alarm appears, such as on battery low voltage.
One beep every 3.3 seconds	Generated when a UPS general alarm appears.

NOTE: When an alarm is indicated, an alarm message is logged. [Table 4-4 on page 55](#), describes the alarm messages you may see. When a fault is indicated, front-panel display list the fault, which are described in [Table 6-2](#) below.

6.2.1. Faults

When the fault indicator is illuminated, the LCD displays the fault. The faults are described in [Table 6-2](#) below.

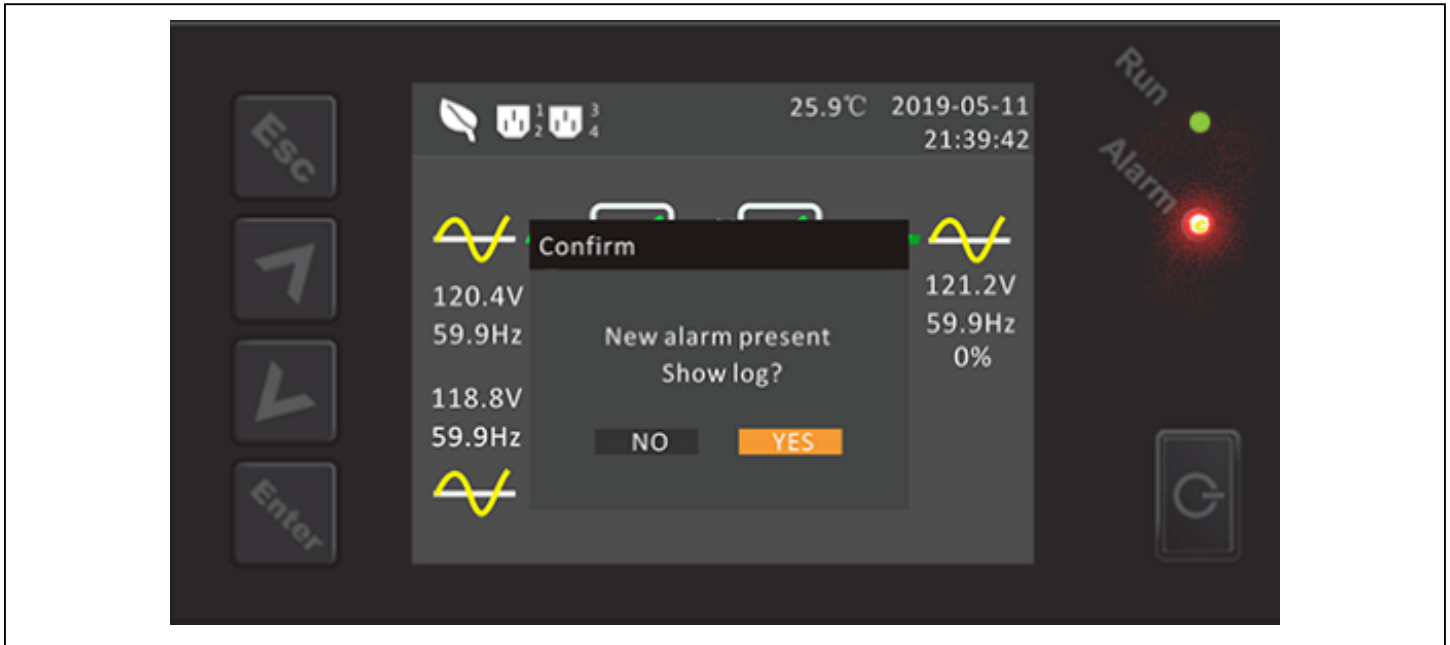

Table 6-2 Description of displayed faults

DISPLAYED FAULT	CAUSE	CORRECTIVE STEPS
Battery test fail	The battery is bad or weak.	Contact technical support.
Rectifier fault	A rectifier failure occurred.	Contact technical support.
Inverter overload, Bypass overcurrent	The UPS is overloaded, Bypass is over current.	Reduce the load and contact technical support.
Inverter fault	The inverter is faulty.	Contact technical support.
Battery aged	The battery is bad or weak.	Replace the battery.
Output short	The output connection is short-circuited.	Shut-down the equipment and contact technical support.
DC bus fail	The DC bus is faulty.	Contact technical support.
System overtemp	Over-temperature condition in the UPS. The UPS will transfer to bypass mode.	Reduce the load and contact technical support.
Charger fault	The charger is faulty.	Contact technical support.
Fan fault	At least one fan is faulty.	Contact technical support.
DC/DC fault	A DC-DC charger failure occurred.	Contact technical support.

6.3. Troubleshooting UPS Issues

In the event of an issue with the UPS, refer to [Table 6-3](#) below, to determine the cause and solution. If the fault persists, contact Vertiv Technical Support. Visit the GXT5 product page at www.vertiv.com for contact information.

When reporting a UPS issue to Vertiv, include the UPS model and serial number. These are located in several places for your ease of location:

- On the top panel (rack mount orientation)
- The left side (tower orientation)
- The rear panel
- On the front of the unit behind the front plastic bezel
- On the LCD select *Main Menu > About*

Table 6-3 Troubleshooting

PROBLEM	CAUSE	SOLUTION
UPS fails to start	UPS is short-circuited or overloaded	Ensure UPS is Off. Disconnect all loads and ensure nothing is lodged in output receptacles. Ensure loads are not defective or shorted internally.
	Batteries are not charged enough or not connected	Check to ensure the internal battery is connected. If it is not, make the connection and try to start the unit. If the battery is connected, leave the UPS connected to input power for 24 hours to recharge batteries, then try to start the unit.
UPS has reduced battery backup time	Batteries are not fully charged	Keep UPS plugged in continuously at least 24 hours to recharge batteries.
	UPS is overloaded	Check load level indicator and reduce the load on the UPS.
	Batteries may not be able to hold a full charge due to age	Replace batteries. Contact your Vertiv representative or Vertiv Technical Support for replacement battery kit.

This page is intentionally left blank.

Chapter 7: Specifications

Table 7-1 UPS Specifications, 5-kVA to 20-kVA models

MODEL GXT5-	5000MVR-T4UXLN	6000MVR-T4UXLN	8000MVR-T6UXLN	10KMVR-T6UXLN	15KMVR-T11UXLN	20KMVR-T11UXLN
RATING	5000 VA/5000 W	6000 VA/6000 W	8000 VA/8000 W	10000 VA/10000 W	15000 VA/15000 W	20000 VA/20000 W
Dimensions, D×W×H, in. (mm)						
Unit	16.9 x 25.6 x 6.8 (430 x 650 x 173)		16.9 x 25.6 x 10.2 (430 x 650 x 261)		16.9 x 26.7 x 18.9 (430 x 680 x 482)	
Shipping	35 x 25.2 x 29.1 (890 x 640 x 740)		35 x 25.2 x 38.6 (890 x 640 x 980)		27.1 x 48.0 x 46.0 (690 x 1220 x 1169)	
Weight, lb.(kg)						
Unit	125.6 (57)		224.8 (102)		396.6 (179.9)	
Shipping	189.6 (86)		295.4 (134)		518.8 (231.0)	
Input AC						
Operating Frequency, Nom.	50 or 60 Hz (factory-default is 60 Hz)					
Factory-default VAC	120/208 VAC at 120 degrees					
User-configurable VAC	100/173V, 100/200, 110/190.5, 110/220, 115/199, 115/230, 120/208, 120/240, 125/216.5, 125/250					
Allowable Input Phase Angle	120, 180, 240 degrees, auto-sensing on application of alternating current.(Restrictions for L-N voltages other than 120 VAC.)					
Input Frequency without Battery Operation	40 – 70 Hz					
Input Power Connection	Hard-wired terminal block 3W+ G (L1-L2-N-G)					
L1-N, L2-N Maximum Allowable VAC	150 VAC					
Output AC						
Factory-default VAC	120/208 VAC at 120 degrees					
L1-L2 Factory-default Output Phase Angle	120 degrees					
Allowable Output Phase Angle	120, 180, 240 degrees, auto-sensing on initial application of input AC					
Factory-default L1-N, L2-N VAC	120 VAC nominal					
L1-N, L2-N, Operating Load Range	105% to 125% for 5 minutes 125% to 150% for 60 seconds >150% (impact load) minimum 200 ms					
Bypass Protection Limits						
Re-enable Bypass Operation	If input voltage returns to within ±10% nominal output voltage					
Disable Bypass Operation	When the input frequency prevents synchronous operation.					
Battery Parameters						
Type	Valve-regulated, non-spillable, flame-retardant, lead acid					
Quantity x Voltage x Rating	12 x 12V x 9.0AH		24 x 12V x 9.0AH		48 x 12V x 9.0AH	
Battery Mfr./Part #	LEOCH DJW12-90					
Back-up time	See Battery Run Times on page 86 .					
Recharge time	5 hours to 90% capacity after full-discharge into 100% load.					
Charger Current, A	2.25 A (default), maximum 5 A					

Table 7-1 UPS Specifications, 5-kVA to 20-kVA models (continued)

MODEL GXT5-	5000MVR-T4UXLN	6000MVR-T4UXLN	8000MVR-T6UXLN	10KMVR-T6UXLN	15KMVR-T11UXLN	20KMVR-T11UXLN
RATING	5000 VA/5000 W	6000 VA/6000 W	8000 VA/8000 W	10000 VA/10000 W	15000 VA/15000 W	20000 VA/20000 W
Environmental						
Operating Temperature, °F (°C)	32 to 104 (0 to 40) (no derating)					
Storage Temperature, °F (°C)	5 to 104 (-15 to 40)					
Relative Humidity	0 – 95% non-condensing					
Operating Elevation	Up to 10,000 ft (3,000 m) at 77°F (25°C) without derating					
Audible Noise	<50 dBA, at 3.2 ft (1 m) from the front and sides, <55 dBA, at 3.2 ft (1 m) from rear				<58 dBA, at 3.2 ft (1 m) from the front and sides,	
Agency						
Safety	UL1778, c-UL listed					
RFI/EMI	FCC Part 15 (Class A)					
EMC	IEEE/ANSI C62.41 Category B					
Surge Immunity	IEEE/ANSI C62.41 Category B					
Transportation	ISTA Procedure 1A					

Table 7-2 Power-output Distribution (POD) Specifications for 5-kVA to 6-kVA Models

MODEL PD5-	HDWR-MBS	001	002	003	004	005	006	007
Dimensions, D×W×H, in. (mm)								
Unit	5.2 x 15.5 x 3.5 (132 x 394 x 89)							
Shipping	9.5 x 20.7 x 9.1 (560 x 250 x 200)							
Weight, lb.(kg)								
Unit	6 (2.7)	8.8 (4.0)	8.6 (3.9)	9.9 (4.5)	10.6 (4.8)	9.5 (4.3)		
Shipping	8.2 (3.7)	11 (5)	10.8 (4.9)	12.1 (5.5)	12.8 (5.8)	11.7 (5.3)		
Electrical Specifications								
Rating when installed on 5-kVA	Factory Default	5000VA/4500W						
Rating when installed on 6-kVA	Factory Default	6000VA/5100W						
Input Power Connection	Hard-Wired Terminal Block 3W + G (L-L-N- G)	(1) L14-30P on a 10.5-ft (3.2-m) cord (1)						
Output Power Connection	Hard-Wired Terminal Block 3W + G (L-L-N- G)	(4) 5-20R (1) L14-30R (1) L6-30R	(2) 5-20R (2) L6-20R	(4) 5-20R (2) L6-30R	(4) L5-20R (2) L5-30R	(4) L5-20R (2) L6-30R	(4) L6-20R	(2) L5-20R (2) L6-20R

Table 7-3 Power-output Distribution (POD) Specifications for 8-kVA to 20-kVA Models

MODEL PD2-	101	102	103	104	105	106	107	108	109
Dimensions, D×W×H, in. (mm)									
Unit	7.4 x 5.7 (188 x 145)								
Shipping	11.9 x 20.6 x 8.7 (302 x 522 x 220)								
Weight, lb.(kg)									
Unit	4.4 (2)	6.6 (3)			4.4 (2)	6.6 (3)			
Shipping	6.6 (3)	8.8 (4)			6.6 (3)	8.8 (4)			
Electrical Specifications									
Amp Rating	2-pole 60-A input breaker								
Input Power Connection	Custom connector 3W+ G (L1-L2-N-G) to UPS								
Output Power Connection	(2) L6-30R (8) 5-20R	(4) L6-20R (4) 5-20R	(4) 5-20R (4) L6-30R	(4) 5-20R (2) L6-30R (2) L6-20R	(4) 5-20R (2) L5-30R (2) L5-20R	(4) L6-20R (4) L5-20R	(4) L5-20R (4) 5-15/20R	(2) L6-20R (2) L6-30R	(2) L14-30R

Table 7-4 Additional Power-output Distribution (POD) Specifications for 8-kVA to 20-kVA Models

MODEL PD2-	200	201	202	204
Dimensions, D×W×H, in. (mm)				
Unit	7.4 x 5.7 (188 x 145)			
Shipping	11.9 x 20.6 x 8.7 (302 x 522 x 220)			
Weight, lb.(kg)				
Unit	6.6 (3)	4.4 (2)		6.6 (3)
Shipping	15 (6.8)	6.6 (3)		15 (6.8)
Electrical Specifications				
Amp Rating	2-pole 60-A input breaker			
Input Power Connection	Custom connector 3W + G (L1-L2-N- G) to UPS			
Output Power Connection	(4) IEC320-C19 (4) IEC320-C13	(2) IEC320-C19 (8) IEC320-C13	(12) IEC320-C13	(2) IEC309-32A (4) IEC320-C13

Table 7-5 External Battery Cabinet Specifications

MODEL NUMBER	GXT5-EBC144VRT2U	GXT5-EBC288VRT4U	GXT5-EBC288VRT8U
USED W/UPS MODEL	5 – 6-KVA MODELS	8 – 10-KVA MODELS	15-20-KVA MODELS
Dimensions, D×W×H, in. (mm)			
Unit (with bezel)	17.5 x 26.5 x 3.5 (430 x 650 x 85)	17.5 x 26.5 x 7.1 (430 x 650 x 173)	16.9×26.7×13.6 (430 x 680 x 346)
Shipping	35.5 x 25.7 x 19.8 (845 x 630 x 485)	35.5 x 25.7 x 23.2 (845 x 630 x 570)	26.4×34.6×34.1 (670 x 880 x 867)
Weight, lb.(Kg)			
Unit	81.6 (37)	189.6 (86)	361.6 (164)
Shipping	123.5	233.7	418.9 (190)
Battery			
Type	Valve-regulated, non-spillable, lead acid		
Qty × Voltage	12 x 12V	24 x 12V	48 x 12V
Battery Mfr./Part#	LEOCH DJW12-9.0		
Backup time	See Battery Run Times on page 86.		
Environmental Requirements			
Operating Temperature, °F (°C)	32 to 104 (0 to 40)		
Storage Temperature, °F (°C)	5 to 122 (-15 to 50)		
Relative Humidity	0% to 95%, non-condensing		
Operating Elevation	Up to 10,000 ft (3,000 m) at 104 °F (40 °C)		
Agency			
Safety	UL1778 4th Edition and CSA 22.2 No. 107.1		
RFI/EMI	FCC Part 15 Class A		
Transportation	ISTA Procedure 1A		

7.1. Battery Run Times

NOTE: Run times in this table are approximate. Times are based on new, fully-charged, standard battery modules at a temperature of 77 °F (25 °C) with 100% resistive UPS loading. Run times listed above can vary by ±5% due to manufacturing variances of the individual batteries.

Table 7-6 Battery Run Time in Minutes, GXT5-5000MVRT4UXLN

LOAD			INTERNAL BATTERY ONLY	NUMBER OF EXTERNAL BATTERY CABINETS									
				1	2	3	4	5	6	7	8	9	10
%	VA	W											
10	500	500	87.0	195.0	311.0	427.5	543.5	660.0	776.0	892.5	1009.0	1125.0	1241.5
20	1000	1000	41.5	94.0	149.0	211.0	273.5	335.5	397.5	460.0	522.0	584.5	646.5
30	1500	1500	24.5	61.0	97.0	133.0	175.0	218.0	260.5	303.0	345.5	388.0	430.5
40	2000	2000	16.5	44.0	71.5	99.0	126.5	157.5	190.0	222.5	255.5	288.0	320.5
50	2500	2500	12.5	33.0	55.5	78.0	100.0	122.5	146.5	173.0	199.0	225.5	252.0
60	3000	3000	9.5	25.5	44.5	63.5	82.0	100.5	119.0	138.5	160.5	182.5	204.5
70	3500	3500	7.5	20.5	36.5	53.0	69.0	85.0	101.0	117.0	133.0	151.5	170.5
80	4000	4000	6.5	17.0	30.5	45.0	59.0	73.0	87.0	101.0	115.0	129.0	145.0
90	4500	4500	5.0	14.5	26.0	38.5	51.5	64.0	76.5	89.0	101.5	114.0	126.5
100	5000	5000	4.5	12.5	22.5	33.5	45.0	56.5	68.0	79.0	90.0	101.5	113.0

Table 7-7 Battery Run Time in Minutes, GXT5-6000MVRT4UXLN

LOAD			INTERNAL BATTERY ONLY	NUMBER OF EXTERNAL BATTERY CABINETS									
				1	2	3	4	5	6	7	8	9	10
%	VA	W											
10	600	600	72.5	160.0	258.5	357.5	456.5	555.0	654.0	752.5	851.5	950.5	1049.0
20	1200	1200	33.0	77.5	122.0	172.0	224.5	277.0	329.5	382.0	434.5	487.0	539.5
30	1800	1800	19.0	49.5	80.0	110.0	142.0	178.0	213.5	249.5	285.5	321.5	357.5
40	2400	2400	13.0	35.0	58.5	81.5	104.5	128.0	154.0	181.5	209.0	236.5	263.5
50	3000	3000	9.5	25.5	44.5	63.5	82.0	100.5	119.0	138.5	160.5	182.5	204.5
60	3600	3600	7.5	20.0	35.5	51.0	66.5	82.0	98.0	113.5	129.0	146.5	165.0
70	4200	4200	6.0	16.0	28.5	42.0	56.0	69.0	82.5	96.0	109.0	122.5	136.5
80	4800	4800	4.5	13.5	24.0	35.5	47.5	59.5	71.0	82.5	94.5	106.0	118.0
90	5400	5400	4.0	11.5	20.0	30.5	41.0	51.5	62.0	72.5	83.0	93.5	104.0
100	6000	6000	3.5	9.5	17.5	26.0	35.5	45.5	55.0	64.5	73.5	83.0	92.5

Table 7-8 Battery Run Time in Minutes, GXT5-8000MVRT6UXLN

LOAD			INTERNAL BATTERY ONLY	NUMBER OF EXTERNAL BATTERY CABINETS									
				1	2	3	4	5	6	7	8	9	10
%	VA	W											
10	800	800	118	267.5	420	572.5	725	878	1030.5	1183	1335.5	1488	1640.5
20	1600	1600	56.5	124.5	203	283	363	443.5	523.5	603.5	684	764	844
30	2400	2400	35	81.5	128	181.5	236.5	291	346	400.5	455.5	510	565
40	3200	3200	23.5	59	93.5	128.5	169	210.5	251.5	293	334.5	375.5	417
50	4000	4000	17	45	73	101	129	161.5	195	228	261	294.5	327.5
60	4800	4800	13.5	35.5	59.5	82.5	106	129.5	156.5	184.5	212	240	267.5
70	5600	5600	10.5	29	49.5	69.5	89.5	110	130	153	177	201	225
80	6400	6400	9	24	42	59.5	77.5	95	112.5	130.5	150.5	171.5	192.5
90	7200	7200	7.5	20.5	36	52	67.5	83.5	99	115	130.5	148.5	167.5
100	8000	8000	6.5	17.5	31	45.5	60	74	88	102.5	116.5	131	147

Table 7-9 Battery Run Time in Minutes, GXT5-10KMVRT6UXLN

LOAD			INTERNAL BATTERY ONLY	NUMBER OF EXTERNAL BATTERY CABINETS									
				1	2	3	4	5	6	7	8	9	10
%	VA	W											
10	1000	1000	94.0	211.0	335.5	460.0	584.5	708.5	833.0	957.5	1082.0	1206.0	1330.5
20	2000	2000	44.0	99.0	157.5	222.5	288.0	353.0	418.0	483.0	548.0	613.5	678.5
30	3000	3000	25.5	63.5	100.5	138.5	182.5	226.5	270.5	314.5	358.5	402.5	446.5
40	4000	4000	17.0	45.0	73.0	101.0	129.0	161.5	195.0	228.0	261.0	294.5	327.5
50	5000	5000	12.5	33.5	56.5	79.0	101.5	124.0	149.0	175.5	202.5	229.0	255.5
60	6000	6000	9.5	26.0	45.5	64.5	83.0	102.0	121.0	140.5	163.0	185.5	207.5
70	7000	7000	7.5	21.0	37.0	54.0	70.0	86.0	102.0	118.5	135.0	154.0	173.0
80	8000	8000	6.5	17.5	31.0	45.5	60.0	74.0	88.0	102.5	116.5	131.0	147.0
90	9000	9000	5.5	15.0	26.5	39.5	52.0	65.0	77.5	90.0	102.5	115.5	128.0
100	10000	10000	4.5	13.0	23.0	34.5	46.0	57.5	69.0	80.5	91.5	103.0	114.5

Table 7-10 Battery Run Time in Minutes, GXT5-15KMVRT11UXLN

NOTE: EBCs must be connected in pairs to these models. See [Figure 2-4](#) for details.

LOAD			INTERNAL BATTERY ONLY	NUMBER OF PAIRS OF EXTERNAL BATTERY CABINETS									
				1	2	3	4	5	6	7	8	9	10
%	VA	W											
10	1500	1500	133.0	303.0	473.0	643.5	814.0	984.0	1154.5	1324.5	1495.0	1665.0	1835.5
20	3000	3000	63.5	138.5	226.5	314.5	402.5	491.0	579.0	667.0	755.0	843.0	931.0
30	4500	4500	38.5	89.0	140.0	199.0	258.0	317.5	376.5	435.5	494.5	554.0	613.0
40	6000	6000	26.0	64.5	102.0	140.5	185.5	230.0	274.5	319.0	363.5	408.0	453.0
50	7500	7500	19.0	49.5	79.5	110.0	141.5	177.0	213.0	249.0	284.5	320.5	356.0
60	9000	9000	15.0	39.5	65.0	90.0	115.5	142.0	172.0	202.0	232.0	262.0	291.5
70	10500	10500	12.0	32.0	54.5	76.0	98.0	120.0	143.0	169.0	194.5	220.5	246.5
80	12000	12000	10.0	27.0	46.5	65.5	85.0	104.0	123.5	144.0	167.0	189.5	212.5
90	13500	13500	8.5	23.0	40.0	57.5	74.5	91.5	108.5	125.5	144.0	164.5	184.5
100	15000	15000	7.0	19.5	34.5	50.5	66.0	81.0	96.5	112.0	127.5	144.5	162.5

Table 7-11 Battery Run Time in Minutes, GXT5-20KMVRT11UXLN

LOAD			INTERNAL BATTERY ONLY	NUMBER OF PAIRS OF EXTERNAL BATTERY CABINETS									
				1	2	3	4	5	6	7	8	9	10
%	VA	W											
10	2000	2000	99.0	222.5	353.0	483.0	613.5	743.5	873.5	1004.0	1134.0	1264.5	1394.5
20	4000	4000	45.0	101.0	161.5	228.0	294.5	361.0	427.0	493.5	560.0	626.5	693.0
30	6000	6000	26.0	64.5	102.0	140.5	185.5	230.0	274.5	319.0	363.5	408.0	453.0
40	8000	8000	17.5	45.5	74.0	102.5	131.0	164.0	197.5	231.0	265.0	298.5	332.0
50	10000	10000	13.0	34.5	57.5	80.5	103.0	126.0	151.5	179.0	206.0	233.0	260.0
60	12000	12000	10.0	27.0	46.5	65.5	85.0	104.0	123.5	144.0	167.0	189.5	212.5
70	14000	14000	8.0	21.5	38.0	55.0	71.0	87.5	104.0	120.5	137.5	157.0	176.5
80	16000	16000	6.5	18.0	32.0	46.5	61.0	75.5	89.5	104.0	118.5	133.0	150.0
90	18000	18000	5.5	15.0	27.0	40.0	53.0	66.0	78.5	91.5	104.0	117.0	130.0
100	20000	20000	4.5	13.0	23.0	34.5	46.5	58.0	69.5	81.0	92.5	104.5	116.0

This page is intentionally left blank.

Appendix I: Open Source Software Legal Notices

The GXT5 product links the FreeRTOS software with Vertiv Group Corporation's proprietary modules that communicate with the FreeRTOS software solely through the FreeRTOS API interface. This use is an exception to the FOSS GPLv2 license. The user is free to redistribute the FreeRTOS software and/or modify it under the terms of the GNU General Public License as published by the Free Software Foundation. A copy of the GNU General Public License is located at www.gnu.org/licenses/old-licenses/gpl-2.0.html. A copy of the exception is located at <https://spdx.org/licenses/freertos-exception-2.0.html>. For a period of three (3) years after purchasing the GXT5 product, the purchaser has the right to obtain a copy of the FreeRTOS software that is incorporated in the GXT5 product. The purchaser can contact Vertiv Technical Support and request the software.

This page is intentionally left blank.

Appendix II: Technical Support

Our Technical Support staff is ready to assist you with any installation or operating issues you may encounter with your Liebert® product. Please call or e-mail us:

In the United States

Technical support

e: liebert.upstech@vertiv.com

p: 1-800-222-5877 menu option 1

Monitoring support

e: liebert.monitoring@vertiv.com

p: 1-800-222-5877 menu option 2

Warranty support

e: microups.warranty@vertiv.com

p: 1-800-222-5877 menu option 3

In Europe, Middle East, and Asia

EMEA Multi-Language Technical support

e: eoc@vertiv.com

p: Toll free 0080011554499

p: Toll +39 02 98250222



© 2020 Vertiv Group Corp. All rights reserved. Vertiv™ and the Vertiv logo are trademarks or registered trademarks of Vertiv Group Corp. All other names and logos referred to are trade names, trademarks or registered trademarks of their respective owners. While every precaution has been taken to ensure accuracy and completeness here, Vertiv Group Corp. assumes no responsibility, and disclaims all liability, for damages resulting from use of this information or for any errors or omissions. Specifications, rebates and other promotional offers are subject to change at Vertiv's sole discretion upon notice.

SL-70524_REV3_06-20