

BDS–256XL Discrete Reading Battery Diagnostic System Installation Instructions



Vertiv Corporation
1050 Dearborn Drive
Columbus, OH 43085
Tel: (954) 377-7101
www.vertivco.com

590-2100-501A/SL-29415/4200-075

The information contained in this document is subject to change without notice and may not be suitable for all applications. While every precaution has been taken to ensure the accuracy and completeness of this document, Vertiv assumes no responsibility and disclaims all liability for damages resulting from use of this information or for any errors or omissions. Refer to other local practices or building codes as applicable for the correct methods, tools, and materials to be used in performing procedures not specifically described in this document.

The products covered by this instruction manual are manufactured and/or sold by Vertiv. This document is the property of Vertiv and contains confidential and proprietary information owned by Vertiv. Any copying, use or disclosure of it without the written permission of Vertiv is strictly prohibited.

Notice to Users

Vertiv Corporation reserves the right to make changes to this document without notice to any user or reseller of this product. Vertiv Corporation also reserves the right to substitute or terminate distribution of this document, with no obligation to notify any person or party of such substitutions or terminations.

Copyright and Disclaimer

BDS–256XL Discrete Reading Battery Diagnostic System Installation Instructions

Vertiv Customer Service

Vertiv Customer Service is available Monday to Friday, 8:00AM to 4:30PM Eastern Time.

Telephone: (954) 377-7101
Email: alber-service@vertivco.com
Website: www.vertivco.com

Corporate Office Address:
Vertiv Corporation
1050 Dearborn Drive
Columbus, OH 43085



EUROPEAN UNION CUSTOMER NOTICE: Disposal of Old Appliances*

This product uses components that are dangerous for the environment, such as electronic cards and other electronic components. Any component that is removed must be taken to specialized collection and disposal centers. If this unit must be dismantled, this must be done by a specialized center for collection and disposal of electric and electronics appliances or other dangerous substances. This product has been supplied from an environmentally aware manufacturer that complies with the Waste Electrical and Electronic Equipment (WEEE) Directive 2002/96/EC. The "crossed-out wheeled bin" symbol to the left is placed on this product to encourage you to recycle wherever possible.

Please be environmentally responsible and recycle this product through your recycling facility at its end of life. Do not dispose of this product as unsorted municipal waste. Follow local municipal waste ordinances for proper disposal provisions to reduce the environmental impact of waste electrical and electronic equipment (WEEE) Directive 2012/19/EU.

For information regarding the scrapping of this equipment, go to www.eu.emersonnetworkpower.com ("Products" or "Contact us" sections) or call Emerson's worldwide technical support at: **00 80011554499 (Toll free number) or +39 0298250222 (Toll number based in Italy)**

**This notice only applies to 50Hz units placed on the European Union market.*

Table of Contents

1	FCC DECLARATION OF CONFORMITY	1
2	REGULATORY INFORMATION	1
2.1	Type Of Service	1
2.2	Telephone Company Procedures.....	1
3	SERVICE	1
4	SAFETY	2
4.1	General.....	2
4.2	Before Applying Power.....	2
4.3	Ground the Equipment/Chassis.....	2
4.4	Fuses.....	3
4.5	Do Not Remove Equipment Cover	3
4.6	Do Not Operate Damaged Equipment.....	3
4.7	Do Not Service or Adjust Alone	3
4.8	Do Not Substitute Parts or Modify Equipment	4
4.9	Ensure Rack/Chassis/Shelving/Mounting Stability.....	4
4.10	Radiated Immunity	4
4.11	Insulation Rating for Wires	4
4.12	Ventilation	4
4.13	Drawings.....	4
4.14	Warning.....	4
4.15	Caution	4
4.16	NOTE:.....	5
4.17	SAFETY SYMBOLS.....	5
5	EMERGENCY SHUTDOWN SWITCH/ DISCONNECT DEVICE	5
5.1	BDS-40 Disconnect Device	5
5.2	UNINTERRUPTIBLE POWER SUPPLY UPS	5
5.3	Preventive Maintenance.....	5
5.3.1	Visual Inspection	5
5.3.2	Cleaning System Components	6
5.3.3	Fans and Vents.....	6
5.3.4	Sense Leads (When Applicable)	6
5.3.5	Internal Components.....	6
5.3.6	Shipping, Storage, Normal Use Protection	6
6	PRODUCT OVERVIEW THE BDS-256XL DISCRETE READING SYSTEM	7
6.1	Measurement Capabilities.....	7
6.2	Features.....	7
6.2.1	Standard	7
6.2.2	Optional.....	7
6.2.3	Alarm Features.....	7
6.3	Model Number.....	8
6.3.1	CM-XL8 Controller Module Model Number Description	8
6.3.2	DCM-XL48d Data Collection Module Model Number Description	9

6.3.3	RTM–XLR Resistance Test Module Model Number Description.....	9
6.4	Materials	10
6.4.1	Standard	10
6.4.2	Optional.....	16
6.5	Tools	18
6.6	Building Management System Integration	20
6.7	Panel Controls And Indicators	21
6.7.1	CM–XL8	22
6.7.2	DCM–XL48d	25
6.7.3	RTM–XLR	26
6.8	BDS-256XL External Power Supply	27
6.8.1	Front Panel Indicators	27
6.8.2	Fuses.....	28
6.10	29	
6.11	Specifications.....	29
6.11.1	BDS–256XL System Specifications.....	29
6.11.2	Cabinet Specifications.....	31
6.11.3	CM–XL8 Controller Specifications	32
6.11.4	DCM–XL48d Specifications.....	33
6.11.5	RTM–XLR Resistance Test Module Specifications.....	34
7	BEFORE SYSTEM INSTALLATION	36
7.1	Required Drawings.....	36
7.2	System Configuration.....	36
7.3	Location Consideration.....	38
7.3.1	Power.....	38
7.3.2	Physical Mounting	38
7.3.3	Check Service Access.....	39
7.3.4	Maximum Wire And Cable Lengths	39
7.3.5	AC Power Distribution	39
7.3.6	Fiber Optic Cable And DCM Communication Information.....	39
7.3.7	Conduit.....	41
7.3.8	Panduit.....	41
8	BEGIN SYSTEM INSTALLATION	41
8.1	Identify and Verify Cells, Markings, Load Steps, Configuration, etc.	41
8.2	Fit Tab Washers.....	42
8.3	Voltage Sense Lead Connection Preparation.....	42
8.4	Step By Step Instructions	43
8.5	Sense Lead Harness Routing from DCMs to the Battery.....	49
8.6	Cell Voltage Sense Lead Connections	49
8.7	Intertier Connections	50
8.8	Internal Resistance Test Current Cable Connections	50
8.9	Overall Voltage Sense Leads.....	50
8.10	Resistance Test Module Control Cable Connections.....	51
8.11	Discharge Current Sensor (Optional)	51
8.12	Temperature Sensor (Optional).....	51
8.13	Float Current Sensor (Optional)	51
8.1	Power Distribution Connections	56

8.2	<i>Conduit</i>	58
8.3	<i>System with No Local Computer</i>	58
8.4	<i>System with Local Computer</i>	59
8.5	<i>Alarm Contacts and Remote Alarm Reset</i>	60
9	FINAL STEPS CONNECTING TO BATTERY TERMINALS	60
10	FINAL STEPS COMMUNICATION CONNECTIONS	61
10.1	<i>Communication Connections</i>	61
10.2	<i>Modem</i>	61
10.3	<i>USB</i>	62
10.4	<i>RS-232</i>	62
10.5	<i>RJ-45</i>	63
11	DRAWINGS	64

Table of Figures

Figure 1. CM–XL8 Controller Module Model Numbers	8
Figure 2. DCM–XL48d Data Collection Module Model Numbers	9
Figure 3. RTM–XLR Resistance Test Module Model Numbers	9
Figure 4. Sense Lead Harness.....	10
Figure 5. DCM Temp Discrete Read Sense Lead Harness	10
Figure 6. 2 Cond 16 Ga Black Zip Cord	10
Figure 7. Fiber Optic Cable	11
Figure 8. Fiber Optic Polishing Kit.....	11
Figure 9. CM, DCM, RTM = BDS–256XL Discrete Reading System	11
Figure 10. ELM/DCM Control.....	11
Figure 11. DCM Overall Volts Cable	12
Figure 12. 4 POS/8 POS Pluggable Terminals.....	12
Figure 13. 7' Telephone Cable–UL.....	12
Figure 14. 10 Gauge– ⁵ / ₁₆ " Insulated Ring Term UL	12
Figure 15. BDS Flex Resist w/Butt Splice.....	13
Figure 16. Exterior USB Cable	13
Figure 17. 30 Amp Connector Block–UL	13
Figure 18. 30 Amp Contact	14
Figure 19. ¼" Tab Washer	14
Figure 20. 30 Amp Slo–Blo Ceramic Fuse	14
Figure 21. 12 Gauge UL1015 Red	14
Figure 22. Controller Power Cord(s).....	15
Figure 23. Inline Fuseholder Assembly	15
Figure 24. RS–232 Cable.....	15
Figure 25. ¼" Heat Shrink Tubing	15
Figure 26. Multitel Float Charging Current Probe Kit	16
Figure 27. Ambient Temperature Probe 2900–049	16
Figure 28. Electrolyte Temperature Probe 2900–010.....	16
Figure 29. 600 Amp Current Transducer CT	17
Figure 30. CT Cable.....	17
Figure 31. Female Disconnect Adapter	17
Figure 32. Anderson Crimping Tool 1309G2	18
Figure 33. Panduit CT–260 Crimper.....	18
Figure 34. Panduit CT–1525 Crimper.....	18
Figure 35. Panduit CT–1550 Crimper.....	18
Figure 36. Thomas & Betts WT–111–M For Crimper.....	18
Figure 37. #2 Phillips–Head Screwdriver With Insulated Handle	19
Figure 38. Flat–Head Stubby Screwdriver.....	19
Figure 39. Digital Voltmeter.....	19
Figure 40. Computer/PC	20
Figure 41. Molex Crimp Tool	20
Figure 42. BMDM Software Icon	20
Figure 43. http://www.vertivco.com/TechLibraryModbusPage.htm	21
Figure 44. Controller Front Panel With USB CM–XL8	22
Figure 45. CM–XL8 Front Panel Indicators LEDs Explained	22
Figure 46. User Replaceable Fuses 1 And 2 CM–XL8 Rear Panel.....	23
Figure 47. CM–XL8 Input/AC Power Block.....	23
Figure 48. CM–XL8 Output/Load Control/Control Outputs/Digital Inputs	24

Figure 49. CM–XL8 TELCO, Alarms, Reset, Fiber Optic, LAN, RS232	24
Figure 50. DCM–XL48d Front Panel	25
Figure 51. DCM–XL48d Front Panel Indicators Explained	25
Figure 52. DCM–XL48d Rear Panel Connectors Explained	25
Figure 53. DCM–XL48d Rear Panel Controls.....	26
Figure 54. RTM–XLR	26
Figure 55. RTM–XLR LEDs.....	26
Figure 56. RTM–XLR Rear Panel Connectors	27
Figure 57. BDS-256XL External Power Supply Module Front Panel.....	27
Figure 58. BDS-256XL External Power Supply Module Rear Panel Connectors	28
Figure 59. Drawings.....	36
Figure 60. BDS–256XL Configuration Options	38
Figure 61. DCM Fiber Optic Connections.....	40
Figure 62. Minimum Bend Radius Of Fiber Optic Cable	41
Figure 63. BDS Flex Resist W/Butt Splice–10K Ω Flameproof	42
Figure 64. Strip Sense Lead Wire	42
Figure 65. Insert Sense Lead Wire Into 10K Resistor Assembly	42
Figure 66. Crimping With Panduit Crimper	43
Figure 67. Crimping 10k Resistor Assembly To Sense Lead.....	43
Figure 68. Checking 10K Resistor And Sense Lead Connection.....	43
Figure 69. BDS–193–A453 Fuse Protected Load Lead (snapshot)	44
Figure 70. Strip 12 AWG Load Lead Wire	44
Figure 71. #30 Die With Andersen Contact/Pin	44
Figure 72. Inserting Load Lead Wire Into Pin To Crimp.....	45
Figure 73. Crimping Load Lead Wire To Pin	45
Figure 74. Good Crimp.....	45
Figure 75. Andersen Connectors Together	45
Figure 76. Insert Andersen Contact Into Andersen Connector	46
Figure 77. Tug On Assembled Connector	46
Figure 78. Strip 12 AWG Load Lead Wire	47
Figure 79. Thomas And Betts Crimper	48
Figure 80. Crimp Fuseholder Onto Inline Fuseholder Assembly.....	48
Figure 81. Checking Fuseholder/Load Lead Wire Connection.....	48
Figure 82. Securing Fuseholder Load Lead Wire Connection With Heat Shrink.....	49
Figure 83. DCM–XL48d Rear Panel Photo From Drawing BDS–1280–B1205	51
Figure 84. Multitel FCCP Kit pn 5610–053	51
Figure 85. Float Cable.....	52
Figure 86. Multitel FCCP Rear Panel	52
Figure 87. FCCP Connections FCCP.....	53
Figure 88. Multitel's FCCP w/ OPTIONAL Power Source And Inline Fuseholder.....	53
Figure 89. Multitel's FCCP–Routing The Cable	53
Figure 90. Float Current Sensor	53
Figure 91. Section 6.3 Of Multitel's FCCP Installation Manual Pg. 38	54
Figure 92. Section 6.3 Of Multitel's FCCP Installation Manual Pg. 39	55
Figure 93. Snapshot BDS–123–A380	60
Figure 94. Modem Connection On The Rear Of CM–XL8	61
Figure 95. TELCO RJ–11 Modem Connection	61
Figure 96. USB Cable	62
Figure 97. Laptop.....	62
Figure 98. USB Connection CM–XL8 Front Panel.....	62
Figure 99. RS–232 Local Port Rear Panel CM–XL8.....	62

Figure 100. RS-232 9 Pin Female to Female Cable63

Figure 101. RJ-45 Connection Rear Panel CM-XL863

Figure 102. RJ-4563

Figure 103. Full Washer Quick Connect Sense/Load Leads64

Figure 104. Optional Quick Connect Post Clip Leads.....65

Figure 105. 600V Fused Load Lead.....66

Figure 106. Flex Resistor Lead Assembly67

Figure 107. General RTM-XLR Assembly68

Figure 108. General CM-XL8 Assembly69

Figure 109. General DCM-XL48 Assembly70

Figure 110. Current Transducer Connection BDS-256XL.....71

Figure 111. Float Current Transducer Connections.....72

Figure 112. OV/IT Connection Details.....73

Figure 113. Ambient Temperature Cable74

Figure 114. Electrolyte Temperature Cable.....75

Figure 115. Wiring Schematic BDS-256 to (240) 2V Cell Battery76

Figure 116. Wiring Schematic BDS-256XL to (40) 12V Module Battery77

List of Tables

Table 1. F1 And F2 Fuse Ratings Table*	23
Table 2. String and Required DCM Configurations.....	56
Table 3. Power Distribution Connections.....	57

1 FCC DECLARATION OF CONFORMITY

This notice is applicable to Product/System/Hardware/Equipments with the Radio Frequency RF headset communication option installed for Bluetooth®-based communication.

This device complies with Part 15 of the FCC rules. Operation is subject to the following two conditions:

- (i) This device may not cause harmful interference, and
- (ii) This device must accept any interference received, including interference that may cause undesired operations.

2 REGULATORY INFORMATION

2.1 Type Of Service

The MPM Series and the BDS Series VERTIV Product/System/Hardware/Equipment is designed to be used on standard device telephone lines. It connects to the telephone line by means of a standard jack called the USOC RJ11C (or USOC FJ45S). Connection to telephone company provided coin service (central office implemented systems) is prohibited. Connection to party line service is subject to state tariffs.

2.2 Telephone Company Procedures

The goal of the telephone company is to provide you with the best service it can. To do this, it may occasionally be necessary for the company to make changes in its equipment, operations or procedures. If these changes might affect the Original Purchasing End User's service or the operation of the Original Purchasing End User's equipment, the telephone company will give the Original Purchasing End User notice, in writing, to allow the Original Purchasing End User to make any changes necessary to maintain uninterrupted service.

In certain circumstances, it may be necessary for the telephone company to request information from the Original Purchasing End User concerning the equipment that the Original Purchasing End User has connected to the telephone line(s). Upon request of the telephone company, provide the FCC registration number and the Ringer Equivalence Number REN; both of these items are listed on the equipment label. The sum of all the RENs on the telephone line must be less than five in order to assure proper service from the telephone company. In some cases, a sum of five may not be useable on a given line.

3 SERVICE

Proper installation and testing are essential to the correct functioning of the system. If you have questions, contact Vertiv at (954) 377-7101 or fax (954) 377-7042. Request monitor assistance. Except as explained in this manual, do not attempt to service Vertiv equipment.



WARNING:

Opening the equipment may expose personnel to dangerous voltages.

Any adjustment, maintenance, or repair of this product must be performed by qualified personnel or contact a customer engineer through Vertiv, 954-377-7101 Request assistance. Never allow unauthorized personnel to operate the equipment. Only qualified and trained personnel are to perform the operations described in this manual. Calibration must be performed by technically qualified trained personnel.

4 SAFETY

All safety information within must be read, understood and strictly adhered to before installing, powering up or using the equipment/software; i.e. the system.

The following general safety precautions must be observed during all phases of operation, service and repair of this product. Failure to comply with these precautions or with specific WARNINGS elsewhere in this manual violates safety standards of design, manufacture, and intended use of the product. Vertiv assumes no liability for the customer's failure to comply with these requirements.



WARNING:

Use of this system in a manner not specified could compromise the designed-in safety.

4.1 General

For Safety Class 1 equipment, e.g. equipment provided with a protective earth terminal, an uninterruptible safety earth ground must be provided from the main power source to the product input wiring terminal or supplied power cable. The protective features of this product may be impaired if it is used in a manner not specified in the operation/installation instructions. This manual describes the general installation and use of the system. If the system has features or accessories not described in this manual, contact Vertiv at (954) 377-7101 or fax (954) 377-7042.

4.2 Before Applying Power

Check configuration and drawings. Double check all connections. Verify that the system is set to match available voltage, the correct fuses are installed, and all safety precautions are taken.



NOTE:

Notice the system's external markings described under Safety Symbols.



WARNING

High voltage or current may be present inside the equipment and on the equipment terminals.

Observe system's external markings and all electrical safety precautions when removing and installing equipment covers, when connecting leads, and when making adjustments.

Never energize the cabinet or any component with 115VAC (or 230VAC if applicable) or battery voltage until after the installation is complete.

Never exceed equipment voltage, power ratings or capabilities.

4.3 Ground the Equipment/Chassis

Make sure the equipment chassis and/or other system components are properly grounded when required.

To minimize shock hazard, the system chassis and/or cover must be connected to an electrical protective earth ground. The system must be connected to the ac power mains through a grounded power cable, with the ground wire firmly connected to an electrical/safety ground at the power outlet.

 **WARNING**

Any interruption of the protective (grounding) conductor or disconnection of the protective earth terminal will cause a potential shock hazard that could result in personal injury.

4.4 Fuses

For continued protection against fire, only the fuses with the required rated current, voltage, and specified type, i.e. normal slo-blo, blow, time delay, etc. must be used.

 **WARNING**

Do not use repaired fuses or short-circuited fuse holders. To do so could cause a shock or fire hazard.

Some fuses may not be easily removed, contact Vertiv at 954-377-7101. Request monitor assistance.

4.5 Do Not Remove Equipment Cover

Operating personnel must not remove equipment covers, shields and or panels. Component repair and/or replacement and internal adjustments must be made only by qualified service personnel.

 **WARNING**

Under certain conditions, dangerous voltages may exist even with the equipment switched off.

To avoid dangerous electrical shock, DO NOT perform procedures involving cover, shield and/or panel removal.

4.6 Do Not Operate Damaged Equipment

 **WARNING**

Equipment that appears damaged or defective must be made inoperative and secured against unintended operation until it can be repaired by qualified service personnel.

Whenever it is possible that the safety protection features built into this product have been impaired, either through physical damage, excessive moisture, or any other reason, REMOVE POWER and do not use the product until safe operation can be verified by qualified service personnel. If necessary, request service and repair from Vertiv Sales and Service Office to ensure that safety features are maintained. (954-377-7101)

4.7 Do Not Service or Adjust Alone

 **WARNING**

While in the battery circuit, do not attempt internal service or adjustment of this equipment unless another person, capable of calling for or rendering first aid and resuscitation, is present.

4.8 Do Not Substitute Parts or Modify Equipment

Due to the possible danger of introducing additional hazards, do not install substitute parts or perform any unauthorized modification to the product. If necessary, request service and repair from Vertiv to ensure that safety features are maintained.

4.9 Ensure Rack/Chassis/Shelving/Mounting Stability

To ensure stability of the test bay, place heavier instruments near the bottom of the rack. Check the location of all equipment (including PCs) for stability. Make sure cabinets are well mounted.

4.10 Radiated Immunity

If and when subjected to abnormally high RFI fields they may affect the operation of the equipment.

4.11 Insulation Rating for Wires

Use only when supplied with the installation kit.

4.12 Ventilation

Never block equipment ventilation openings. The equipment must have adequate ventilation to prevent equipment overheating. If using a cabinet, allow at least 8" clearance on all sides of the cabinet for ventilation. Never block ventilation ports, and ensure the equipment is operated within the temperature and humidity ranges found in the Ventilation Guide Table and within the specifications:

Temperature range:	5°C to 40°C	41°F to 104°F
Humidity range:	0% to 80% RH (non condensing) at 5°C to 31°C	0% to 50% RH (non condensing) at 32°F to 40°C

4.13 Drawings

Drawings and Figures in this manual may be for reference only or may be superseded by later drawings. For the latest information and revision, refer to the drawings supplied with the system. Reference drawings are located in the rear of the manual.

4.14 Warning



WARNING

Denotes a hazard. It calls attention to a procedure, practice, or condition, which, if not correctly performed or adhered to, could result in personal injury or death. Do not proceed beyond a WARNING symbol until the indicated conditions are fully understood and met. Refer to accompanying documents as well as OEM documentation.

4.15 Caution









This symbol/box denotes a hazard. It calls attention to an operating procedure, or condition, which, if not correctly performed or adhered to, could result in damage to or destruction of part or all of the product or permanent loss of data. Do not proceed beyond a CAUTION symbol until the indicated conditions are fully understood and met. Refer to accompanying documents.

4.16 NOTE:

 *This symbol/box contains important information.*

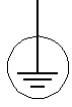
4.17 SAFETY SYMBOLS

	conforms with European standards		warning
	approved by Underwriters Laboratories		caution
	protective earth (ground) terminal		Notice
	frame or chassis terminal		

5 EMERGENCY SHUTDOWN SWITCH/ DISCONNECT DEVICE

In most cases, the three prong AC cord from the cabinet, which connects to the 115VAC or 230VAC receptacle, is considered the primary disconnect device.

5.1 BDS-40 Disconnect Device

The power switch on the rear of the BDS 40 base unit is considered the primary disconnect device.

 **NOTE:**
Different systems may have different disconnect procedures, please refer to the installation instructions or contact Vertiv at 954-377-7101

5.2 UNINTERRUPTIBLE POWER SUPPLY UPS

 **WARNING:**
The BDS system is designed to connect to UPS systems that are 600VDC or less and a maximum of 300V with respect to earth ground. You must verify the voltage with respect to earth ground before connecting the system. Do this by measuring the voltage from each battery post referenced to earth ground. The voltage cannot exceed 300V.

If you are using an optional UPS with the system, be certain the UPS internal battery is functional. Follow instructions in the UPS manufacturer's manual.

5.3 Preventive Maintenance

5.3.1 Visual Inspection

Visually inspect all monitor system components for damaged or frayed power cords and cables, and damaged component panels, controls, and connectors. When damage is detected, remove the equipment from service until the damage is repaired.

5.3.2 Cleaning System Components

Clean system components using a soft cloth, slightly moistened with water. Do not use commercial or industrial cleaners that may attack the computer display and housing. Never expose the computer or system components to water, high humidity or dampness.

**WARNING:**

Before cleaning equipment, ensure the system is disconnected and power to the units has been shut off. You must disconnect system components and the monitor system cabinet, if a cabinet is being used, from AC and/or DC power sources.

5.3.3 Fans and Vents

Remove dust from fans and vents using a small brush or hand held vacuum. Immobilize fan blades to avoid over-speed when using a vacuum.

5.3.4 Sense Leads (When Applicable)

Before cleaning the sense lead clips, ensure the system is disconnected and power to the system has been shut off. Clean the sense leads as required. The acid to which the sense lead clips are exposed during testing must be neutralized often, using a water and baking soda mixture. Brush this mixture onto the sense lead clip, then rinse well with clean, cool tap water. Dry with a clean, soft cloth.

NOTE:

Some equipment and systems may not be equipped with lead clips..

5.3.5 Internal Components

The monitor system has no user–replaceable components. Since high voltage exists in most system components, only knowledgeable users should remove the covers or cowling from components (monitor, UPS, etc.) when required. Failure to comply with this restriction could pose a safety hazard and/or void the system warranty.

**WARNING:**

High voltages exist inside the monitor system components and on the terminals. Calibration must be performed only by technically qualified persons. Observe electrical safety precautions when removing and installing equipment covers and when connecting leads and making adjustments.

5.3.6 Shipping, Storage, Normal Use Protection

Protect the system from physical impact during normal use or storage, and when necessary, provide protection during shipment between test sites.

6 Product Overview The BDS–256XL Discrete Reading System

The BDS–256XL system consists of a CM–XL8 Controller Module, DCM–XL48d Data Collection Modules DCMs, and RTM–XLR Resistance Test Modules RTMs. Additional components may include a Personal Computer PC, a cabinet to house the PC and Controller, a LAN adaptor, DCM tower enclosures, and a DCM external power supply.

6.1 Measurement Capabilities

- ◆ 256 Cells/modules per string
- ◆ 8 Strings maximum
- ◆ Overall Voltage OV
- ◆ 1 Float/Discharge sensor per string
- ◆ 10 Temperature sensors/string–2 max. per DCM
- ◆ Cell Resistance
- ◆ Intercell Resistance–DCM model dependent
- ◆ Intertier Resistance

6.2 Features

This section describes standard and optional BDS–256XL Discrete Reading System features:

6.2.1 Standard

- ◆ Auto detects discharges based on Overall Volts OV or Discharge Current DC, and stores data for real time or accelerated time playback,
- ◆ Scans all pertinent battery parameters, such as overall voltage, cell voltages, and current and temperature/optional,
- ◆ Performs a scheduled resistance test of all cells/jars, intercells and intertiers, and stores results for trending analysis,
- ◆ Communicates with an external computer via USB, RS–232, modem, and LAN, and
- ◆ Is SQL server compatible.

6.2.2 Optional

- ◆ Is network compatible with a network card,
- ◆ Hall effect current transducer for measuring discharge and float current,
- ◆ Temperature sensor: Electrolyte Probe or Contact Ambient Probe,
- ◆ Monitors up to 16 digital inputs, with a digital I/O card or 8 control outputs,
- ◆ Continuous Load Unit CLU control.

6.2.3 Alarm Features

- ◆ 8 control outputs, trigger–able on any alarm event,
- ◆ The monitor may be set to signal if any parameter is outside user–programmed limits, energizes a Form C relay contact, and calls a Central computer to report the alarm condition.
- ◆ The monitor may be set to automatically call the Central computer to report an alarm condition when detected.
- ◆ High and low alarm levels may be programmed on all voltage and temperature parameters, and a high alarm level for resistance.
- ◆ When any parameter goes outside the normal range, the monitor stores the event in memory, the Alarm LED lights, and an alarm relay with a Form C contact energizes.
- ◆ The alarms may be set for latching or non–latching.

6.3 Model Number

The BDS–256XL system consists of:

1. CM–XL8 Controller Module,
2. DCM–XL48d Discrete Reading Data Collection Modules DCMs, and
3. RTM–XLR Resistance Test Modules RTMs.

Additional components may include a Personal Computer PC, a cabinet to house the PC and Controller, a LAN adaptor, DCM tower enclosures, and a DCM external power supply.

6.3.1 CM–XL8 Controller Module Model Number Description

The CM–XL8 Controller model numbers are structured as 1002–nnnxxx, described below.

1002–210	4 Amp output for DCM and RTM power
1002–211	10 Amp output for DCM and RTM power
1002–212	20 Amp output for DCM and RTM power
1002–210–230	4 Amp output for DCM and RTM power
1002–211–230	10 Amp output for DCM and RTM power
1002–212–230	20 Amp output for DCM and RTM power
1002–nnnAxx	A = a modem card is installed
1002–nnnBxx	B = a LAN card is installed
1002–nnnCxx	C = Both a modem and LAN are installed
1002–nnnDxx	D = No modem or LAN is installed
1002–nnnxDx	D = a digital I/O card is installed
1002–nnnx x	Blank = no I/O card
1002–nnnxxL	L = an MLC option is installed
1002–nnnxx	Blank = no MLC option
A typical CM–XL8 Controller part number might be 1002–210BDL	

Figure 1. CM–XL8 Controller Module Model Numbers

NOTE:

Assume 450mA per DCM–XL48d and 1A per RTM–XLR.

6.3.2 DCM-XL48d Data Collection Module Model Number Description

1003-100	DCM-XL48 is Combined Reading
1003-101	DCM-XL48d is Discrete Reading
1003-102	DCM-XL48d is Discrete Reading DCM (field replacement for older units)
1003-103	DCM-XL48d is Combined Reading DCM (field replacement for older units)
1003-106	DCM-XL48 is Combined Reading (Intertiers greater than five)

Figure 2. DCM-XL48d Data Collection Module Model Numbers

6.3.3 RTM-XLR Resistance Test Module Model Number Description



Model Number	Where Used	Model Number	Where Used
1002-244	48V/68V	1002-288	36V/32V
1002-245	48V/80V	1002-289	48V/32V
1002-246	44V	1002-290	48V/16V
1002-247	21V	1002-291	36V/42V
1002-248	48V/40V	1002-292	44V/40V
1002-250	36V	1002-293	48V/8V
1002-251	36V/48V	1002-294	36V/24V
1002-253	36V/72V	1002-295	12V
1002-256	48V	1002-296	24V/32V
1002-257	48V/56V	1002-297	48V/52V
1002-258	48V/54V	1002-298A	24V/16V
1002-259	46V/38V	1002-299	44V/36V
1002-260	44V/42V	1002-301	48V/64V
1002-261	48V/40V	1002-302	10V
1002-263	46V/50V	1002-303	60V/48V
1002-264	48V/36V	1002-304	36V/48V
1002-265	48V/50V	1002-305	36V/30V
1002-278	48V/72V	1002-306	20V
1002-279	48V/60V	1002-307	16V
1002-280	24V/28V	1002-308	23V/22V
1002-281	24V	1002-309	20V/16V
1002-282	60V/36V	1002-310	4V
1002-283	40V		
1002-283	40V		
1002-284	48V/24V		
1002-285	32V		
1002-286	12V/8V		

Figure 3. RTM-XLR Resistance Test Module Model Numbers

6.4 Materials

6.4.1 Standard

Standard Materials

Description	Photo	Purpose
<p>Discrete Read Sense Lead Harness</p> <p>1101-171-xx, 1101-172-xx, 1101-174-xx, and/or 1101-175-xx</p>		<p>Voltage sense lead connection 24 AWG</p> <p>Refer to drawings that were sent with the system as systems are configuration dependent</p>
<p>DCM Temp Discrete Read Sense Lead Harness</p> <p>1101-173-xx, 1101-176-xx</p>		<p>DCM Temperature and Sense Lead connection</p> <p>Refer to drawings that were sent with the system as systems are configuration dependent</p>
<p>2 Cond 16 Ga Black Zip Cord 6002-080</p>		<p>AC power between units, 24VAC connection cord to load module and DCM</p>

Standard Materials

Description	Photo	Purpose
-------------	-------	---------

Fiber Optic Cable
3703–006

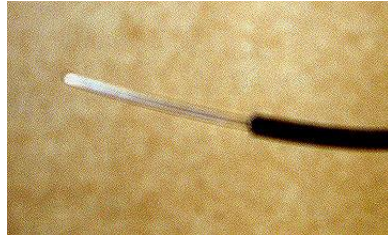

Figure 7. Fiber Optic Cable

Communication link between Controller and DCMs

Fiber Optic Polishing Kit
pn KIT–3703–015



Figure 8. Fiber Optic Polishing Kit

The kit provides the user with polishing materials to terminate the ends of plastic optical fiber correctly.

CM–XL8 = Controller Module, DCM–XL48d = Discrete Reading Data Collection Module DCM, and

RTM–XLR = Resistance Test Modules RTMs.



Figure 9. CM, DCM, RTM = BDS–256XL Discrete Reading System

Battery monitoring system

ELM/DCM Control
1100–496–xx



Figure 10. ELM/DCM Control

ELM/DCM control

Standard Materials

Description	Photo	Purpose
-------------	-------	---------

DCM Overall
Volts Cable
1101-167-xx

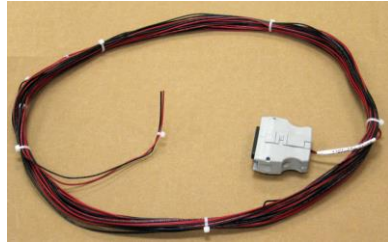

Figure 11. DCM Overall Volts Cable

DCM Overall Volts OV cable assembly—Please refer to wiring schematics that accompanied the equipment as well as drawing BDS-1116-A479.

4 POS/8 POS
Pluggable
Terminals
2140-022 (4)
2140-024 (8)

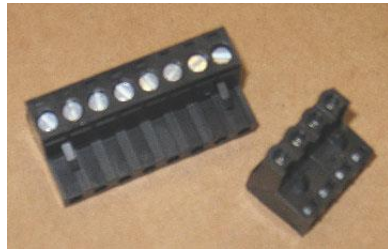

Figure 12. 4 POS/8 POS Pluggable Terminals

Pluggable screw terminals for power and relay connections

7 ft telephone
cable—UL
6003-010



Figure 13. 7' Telephone Cable—UL

Modem/TELCO connection cable



10 gauge— $\frac{5}{16}$ "
insulated ring
terminal UL
2800-109
—used in Inline
Fuse holder
Assembly
1100-433UL





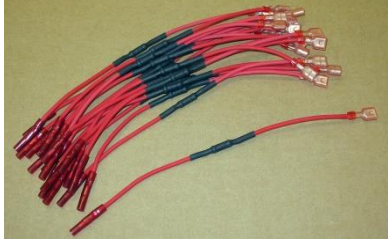

Figure 14. 10 Gauge— $\frac{5}{16}$ " Insulated Ring Term UL

Ring terminal provides connector interface between current transducer and harness. Refer to BDS-193-A453.



Standard Materials

Description	Photo	Purpose
<p>BDS Flex resist w/butt splice 1100–437BS</p>	 <p style="text-align: center;">Figure 15. BDS Flex Resist w/Butt Splice</p>	<p>10K resistor–prevents over current conditions.</p> <p>Refer to BDS–1251–A640</p> <p>NOTE: The sense lead resistor assemblies include a 10KΩ 1% flameproof resistor that reduces the risk of a short circuit during installation and maintenance.</p>
<p>USB2 Hi–speed cable 2025–108</p>	 <p style="text-align: center;">Figure 16. Exterior USB Cable</p>	<p>For system hardware to computer communication.</p>
<p>30 amp connector block–UL 2102–017</p>	 <p style="text-align: center;">Figure 17. 30 Amp Connector Block–UL</p>	<p>Andersen housing/connector block</p> <p>Refer to drawing BDS–193–A453.</p>

Standard Materials

Description	Photo	Purpose
<p>30 amp contact 2102-018</p>		<p>Insert pin/contact for housing/connector</p> <p>Refer to drawing BDS-193-A453.</p>
<p>1/4" tab washer 2120-028</p>		<p>Connector interface between harness and cell—Refer to drawing BDS-123-A380.</p> <div style="border: 1px solid orange; padding: 5px; margin-top: 10px;"> <p>NOTE: Tab washer size is battery dependent, other sizes such as 3/8" and 5/16" are readily available.</p> </div>
<p>30 amp cartridge fuse 4302-030</p>		<p>Load step fuse Please refer to drawing BDS-193-A453</p>
<p>12 gauge UL1015 red 6002-037</p>		<p>Load step wire</p>

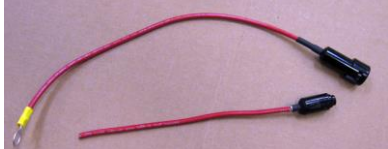
Standard Materials

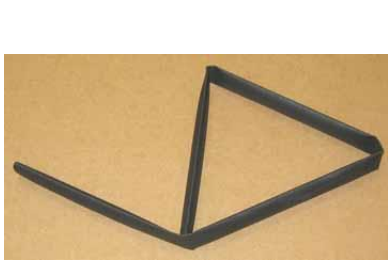
Description	Photo	Purpose
<p>Power Cord 6003-008 = US, 6003-006 = Euro, 6003-007 = UK</p>		<p>Power for the Controller.</p>
<p>Figure 22. Controller Power Cord(s)</p>		
<p>Inline Fuse holder Assembly 1100-433UL</p>		<p>Inline fuse holder</p>
<p>Figure 23. Inline Fuse holder Assembly</p>		
<p>RS-232 serial cable 2025-117</p>		<p>DB9 computer communication cable</p>
<p>Figure 24. RS-232 Cable</p>		
<p>1/4" heat shrink tubing 2880-004—used in Inline Fuse holder Assembly may have 3/8" heat shrink tubing substituted 2880-005</p>		<p>Helps insulate connection</p>
<p>Figure 25. 1/4" Heat Shrink Tubing</p>		

6.4.2 Optional

Optional Materials

Description	Photo	Purpose
-------------	-------	---------

FCCP Kit
5610-053



Figure 26. Multitel Float Charging Current Probe Kit

Float current measurement transducer for a single string. Please refer to drawings BDS-1470-A811

NOTE:
Part number 5610-052 supports two strings and would include one more clamp on probe.

Ambient temperature probe
2900-049

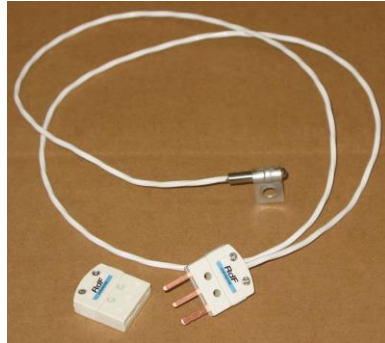

Figure 27. Ambient Temperature Probe 2900-049

Temperature probe that hangs free for ambient temperature measurement. Refer to drawing BDS-136-A397.

Electrolyte temperature probe
2900-010

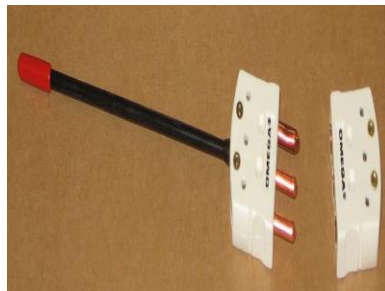

Figure 28. Electrolyte Temperature Probe 2900-010

Teflon coated probe, may be immersed in a flooded cell. Refer to drawing BDS-136-A397.

Optional Materials

Description	Photo	Purpose
-------------	-------	---------

600 amp CT
5610-019

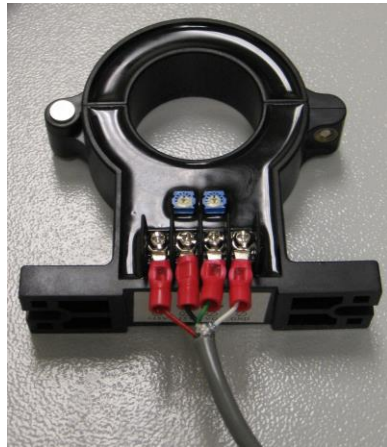

Use Drawing BDS-1132-A501

NOTE:

Photos vary depending upon model(s) chosen up to 3000 Amps

Figure 29. 600 Amp Current Transducer CT

1101-168-xx CT Cable
Or 1101-177-xx Float/CT cable



Figure 30. CT Cable

Please refer to Drawing BDS-1132-A501 for Current Transducer Connection DCM-480-1101-168-xx

and

BDS-1470-A811 for Current Transducer/Float Connections DCM-48XLd 1101-177-xx

female disconnect adapter
2800-129



Figure 31. Female Disconnect Adapter

Voltage sense splitters where single tab needs to multi connect





WARNING:
Never use for load lead wire.

Internal digital I/O card for monitoring 16 digital inputs or controlling eight control outputs. Continuous Load Unit CLU control.



6.5 Tools

The following tools or equivalent are necessary for BDS–256XL Discrete Reading System installation:

TOOLS

Description	Photo	Purpose
Anderson Power Products crimping tool 1309G2 (was 1351G1) Vertiv pn 5400–003	 <p data-bbox="540 625 959 688">Figure 32. Anderson Crimping Tool 1309G2</p>	For crimping 30 amp Anderson connectors. Available from Online Electronics at 800 335–5111 www.onlineelec.com or U.S. Airmotive, Inc. at 305 885–4991 www.usairmotive.com .)
Panduit CT–260 crimper Vertiv pn 5400–002	 <p data-bbox="566 894 935 957">Figure 33. Panduit CT–260 Crimper</p>	For crimping ring terminals and parallel butt splices.
Panduit CT–1525 crimper Vertiv pn 5400–007	 <p data-bbox="558 1125 943 1188">Figure 34. Panduit CT–1525 Crimper</p>	For crimping Please refer to drawing BDS–1251–A640
Panduit CT–1550 crimper Vertiv pn 5400–008	 <p data-bbox="558 1350 943 1413">Figure 35. Panduit CT–1550 Crimper</p>	For crimping ring terminals Please refer to drawing BDS–1251–A640
Thomas and Betts crimper WT–111–M	 <p data-bbox="532 1528 969 1591">Figure 36. Thomas & Betts WT–111–M For Crimper</p>	For crimping fuse holders

TOOLS

Description	Photo	Purpose
#2 Phillips–head screwdriver with insulated handle	 <p data-bbox="560 436 938 533">Figure 37. #2 Phillips–Head Screwdriver With Insulated Handle</p>	For mounting BDS components, and for removing or attaching panels
Flat–head stubby screwdriver	 <p data-bbox="552 968 940 1031">Figure 38. Flat–Head Stubby Screwdriver</p>	For attaching ground wire
Digital Voltmeter	 <p data-bbox="560 1472 938 1499">Figure 39. Digital Voltmeter</p>	Checking voltage.

TOOLS



Description	Photo	Purpose
Computer/Printer LT pn 2025–058 DT pn 2025–054 Printer pn 2025–127		To review data, monitor alarms etc.
Molex Crimp Tool HTR 2445 A pn 5400-006		For crimping specific Molex pins on specific FCCPs
BMDM Software pn 2027–001		Help to monitor the systems and capture data for reporting, etc.

Figure 40. Computer/PC

Figure 41. Molex Crimp Tool

Figure 42. BMDM Software Icon

6.6 Building Management System Integration

The BDS–256XL Discrete Reading system can connect to building management systems. This integration requires writing software that can communicate with the BDS. The communication protocol is MODBUS ASCII. A register map can be obtained by downloading it from www.vertivco.com and/or calling Vertiv at 954-377-7101.

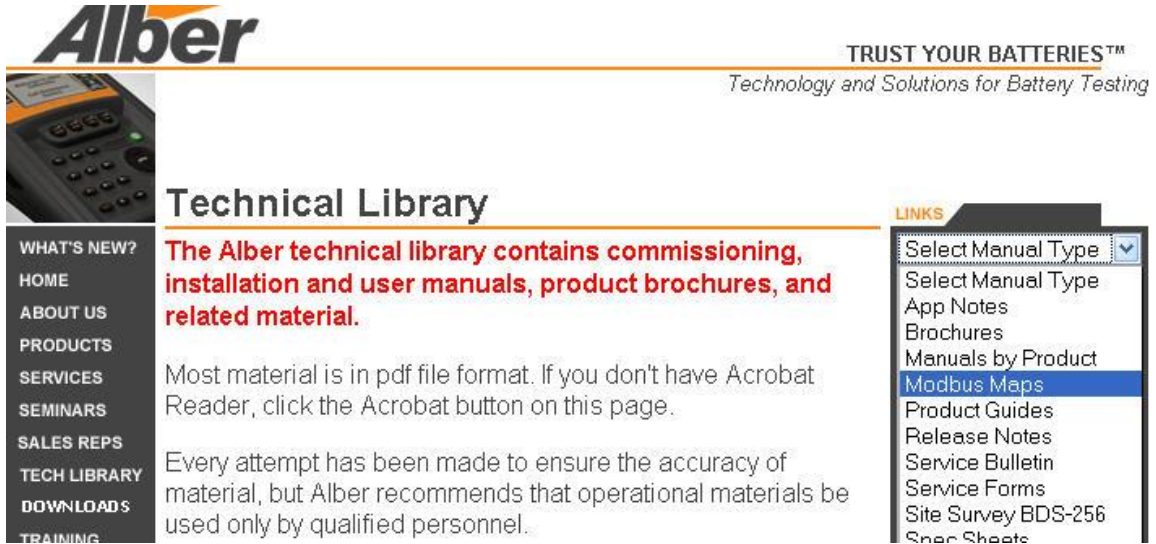

Figure 43. www.vertivco.com

Building Management System Integration connects via LAN RJ–45 or local port located on the rear panel. The only connections made are TX–Pin 2, RX–Pin 3, and GND–Pin 5.

6.7 Panel Controls And Indicators

This section describes the front and rear panels of the components that comprise the BDS–256XL Discrete Reading system. Additional descriptions may appear elsewhere in this manual or in related manuals.

NOTE:

Indicator colors are:

(R)ED,

(Y)ELLOW,

(G)REEN.

The BDS–256XL Discrete Reading system consists of:

1. CM–XL8 Controller Module,
2. DCM–XL48d Discrete Reading Data Collection Modules DCMs, and
3. RTM–XLR Resistance Test Modules RTMs.

Additional components may include a Personal Computer PC, a cabinet to house the PC and Controller, a LAN adaptor, DCM tower enclosures, and a DCM external power supply.

6.7.1 CM–XL8

6.7.1.1 Front Panel Connectors

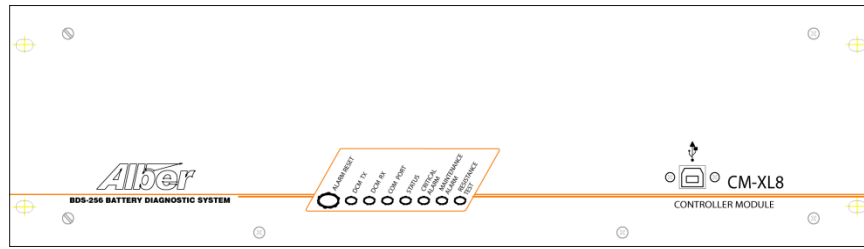

Figure 44. Controller Front Panel With USB CM–XL8

LOCAL PORT



USB port. Connects to a laptop computer

6.7.1.2 Front Panel Controls/Alarm Reset Switch

ALARM RESET Switch

During normal operation, clears latched alarms. If held during power up, clears existing names in the BDS, disables alarms, disables dial out, and resets the password to `alber`.

6.7.1.3 Front Panel Indicators/DCM TX /RX/COM/Status/Alarms And Test

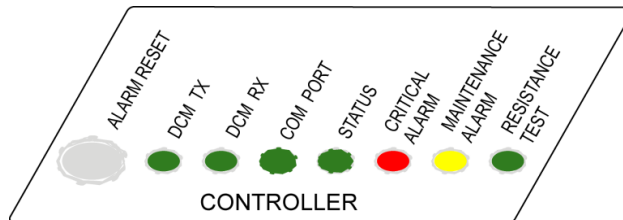

Figure 45. CM–XL8 Front Panel Indicators LEDs Explained

DCM TX (G)REEN	Flashes during fiber optic transmit
DCM RX(G)REEN	Flashes during fiber optic receive
COM PORT (G)REEN	Flashes to indicate communication via LAN port or an incoming call
STATUS (G)REEN	Flashes during normal operating conditions
CRITICAL ALARM (R)ED	Critical alarm detected
MAINTENANCE ALARM (Y)ELLOW	Maintenance alarm detected
RESISTANCE TEST (G)REEN	Performing a manual or automatic resistance test

6.7.1.4 Rear Panel Connectors

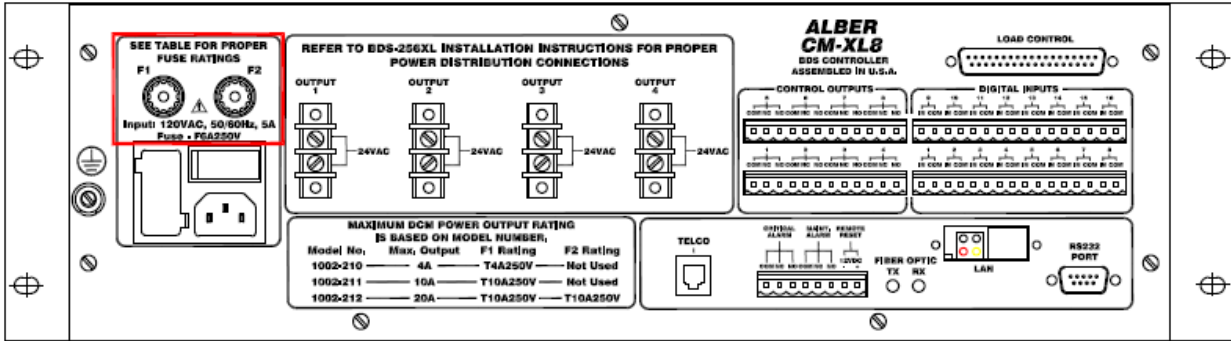

Figure 46. User Replaceable Fuses 1 And 2 CM–XL8 Rear Panel

6.7.1.4.1 Fuses

T10A250V 2 user replaceable fuses. Values based on CM–XL8 model number. See table below.

Model Number	Max. Output	Fuse F1 Rating	Fuse F2 Rating
1002–210	4A	T4A250V	Not Used
1002–211	10A	T10A250V	Not Used
1002–212	20A	T10A250V	T10A250V

Table 1. F1 And F2 Fuse Ratings Table*

*** ⚠ WARNING:**
 This table is provided as a reference only and may not agree with the actual capacity of your system. You must refer to the table on the rear panel of your CM–XL8 to determine the actual fuse values required by your system and the system output capabilities.

6.7.1.4.2 Input/AC Power Block

- ◆ 115VAC 50/60Hz or 230VAC 50/60Hz (Optional)
- ◆ User replaceable fuse and receptacle for AC power cord
- ◆ Power switch for system on/off

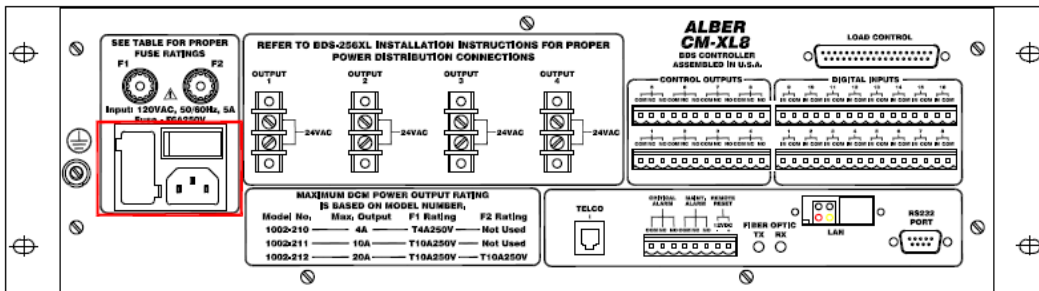

Figure 47. CM–XL8 Input/AC Power Block

6.7.1.4.3 Output/Load Control/Control Outputs/Digital Inputs

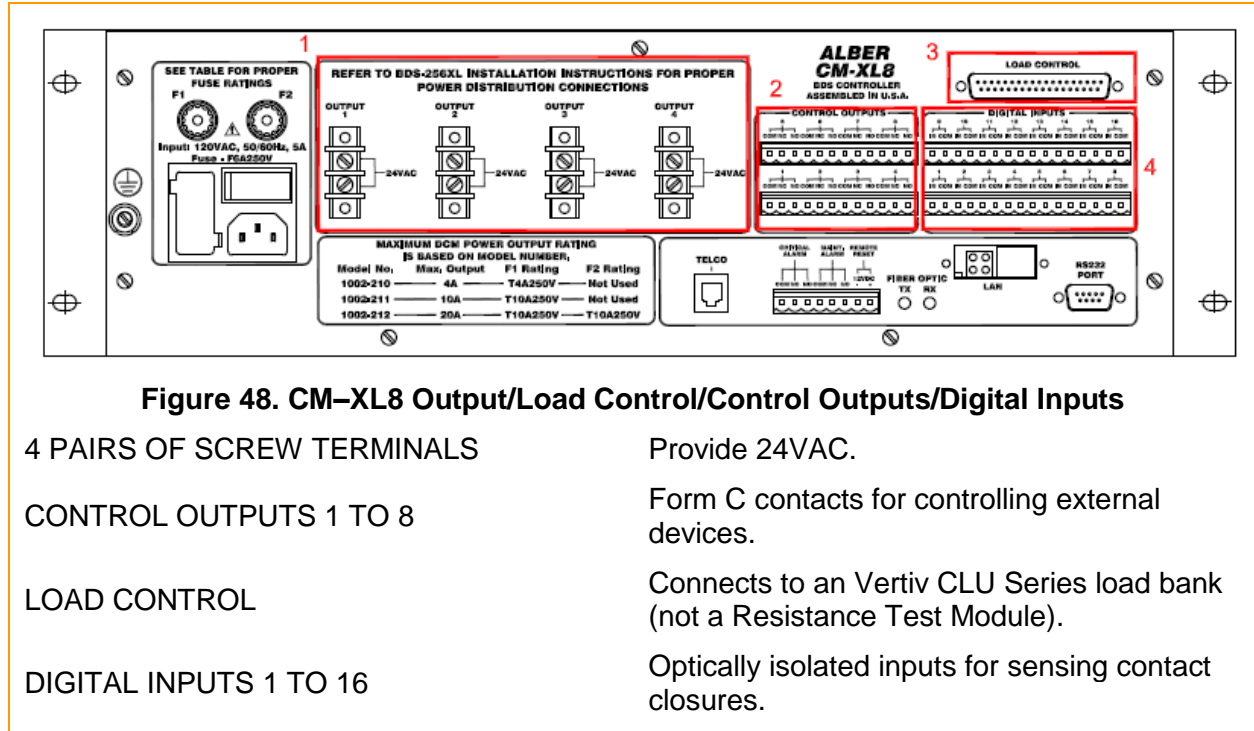

Figure 48. CM–XL8 Output/Load Control/Control Outputs/Digital Inputs

- | | |
|----------------------------|----------------------------------------------------------------------------|
| 4 PAIRS OF SCREW TERMINALS | Provide 24VAC. |
| CONTROL OUTPUTS 1 TO 8 | Form C contacts for controlling external devices. |
| LOAD CONTROL | Connects to an Vertiv CLU Series load bank (not a Resistance Test Module). |
| DIGITAL INPUTS 1 TO 16 | Optically isolated inputs for sensing contact closures. |

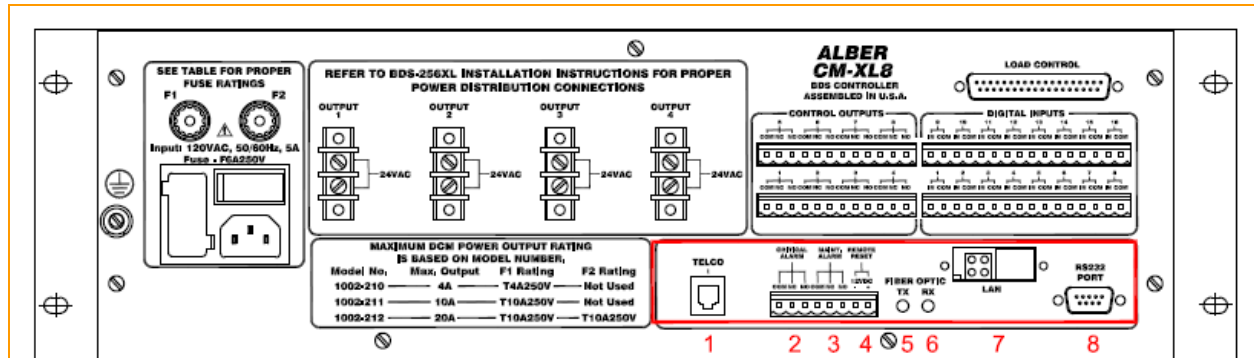

Figure 49. CM–XL8 TELCO, Alarms, Reset, Fiber Optic, LAN, RS232

- | | |
|-----------------------|-------------------------------------------------------------------------------|
| 1. TELCO | RJ–11 jack
Communicates with a remote computer via telephone |
| 2. CRITICAL ALARM | Form C alarm contacts, software configurable |
| 3. MAINT. ALARM | Form C alarm contacts, software configurable |
| 4. REMOTE ALARM | Reads momentary contact closure
Requires a user–supplied 12V to 32V signal |
| 5. FIBER OPTIC TX AND | Fiber Optic transmit / receive ports for DCM communication |
| 6. FIBER OPTIC RX | |
| 7. LAN | RJ–45 port
Communicates with a remote computer via network |

8. RS-232 Port	RS-232 port Connects to a computer (Local port USB is on front panel.)
----------------	------------------------------------------------------------------------------

6.7.2 DCM-XL48d

6.7.2.1 Front Panel Indicators



Figure 50. DCM-XL48d Front Panel

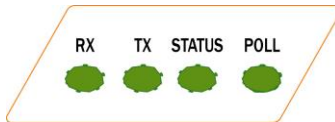

Figure 51. DCM-XL48d Front Panel Indicators Explained

RX (G)REEN	Flashes during fiber optic receive.
TX (G)REEN	Flashes during fiber optic transmit.
STATUS (G)REEN	Flashes during normal operating conditions.
POLL (G)REEN	Flashes during polling from Controller.

6.7.2.2 Rear Panel Connectors

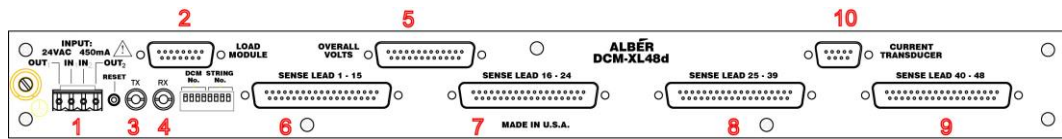

Figure 52. DCM-XL48d Rear Panel Connectors Explained

1. 24VAC 450MA POWER INPUT / OUTPUT	A 4-pin connector for daisy-chaining 24VAC to other DCMs.
2. LOAD MODULE	Control port for Resistance Test Module communication.
3. TX and 4. RX	Fiber Optic transmit / receive ports for communicating with a Controller or other DCMs.
5. OVERALL VOLTS	DB-25 port. Connection for strings Overall Voltage.

<p>6. SENSE LEAD 1 TO 15, 7. SENSE LEAD 16 TO 24/ **TEMPERATURE 1 AND INTERTIERS 1–5 ON DCM MODEL 1002–103 8. SENSE LEAD 25 TO 39 9. SENSE LEAD 40 TO 48/ **TEMPERATURE 2 AND INTERTIERS 6–10 ON DCM MODEL 1002–103</p>	<p>DB–25 ports. Connects voltage sense leads to the batteries. **For sense and power connections for temperature sensors.</p>
<p>10. CURRENT TRANSDUCERS/FLOAT AND DISCHARGE</p>	<p>9–pin. For sense and power connections for float current and discharge current transducers.</p>

6.7.2.3 Rear Panel Controls

Figure 53. DCM–XL48d Rear Panel Controls

1. RESET	Push button to reset the DCM.
2. DCM NO. AND STRING NO.	DIP switches. Sets DCM/string identification.

6.7.3 RTM–XLR

6.7.3.1 Front Panel Indicators

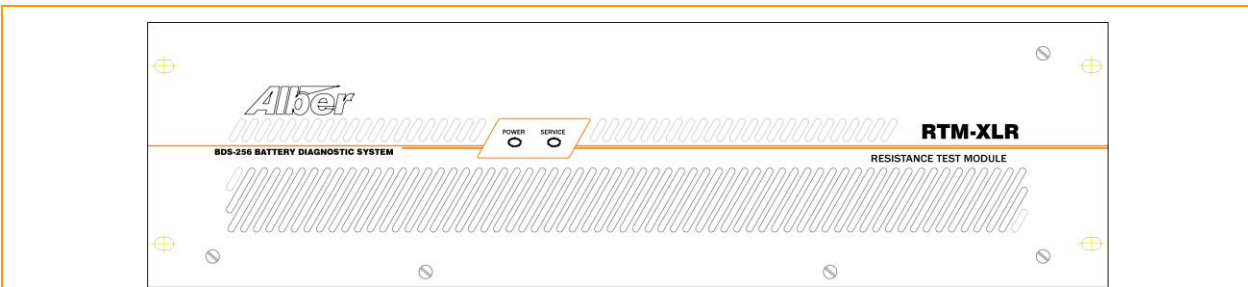

Figure 54. RTM–XLR



Figure 55. RTM–XLR LEDs

- | | |
|------------------|------------------------------------------------------------------------------------------------|
| 1. POWER (G)REEN | 24VAC power is applied |
| 2. SERVICE (R)ED | Unit requires factory service, usually because
internal temperature exceeded specifications |

6.7.3.2 Rear Panel Connectors

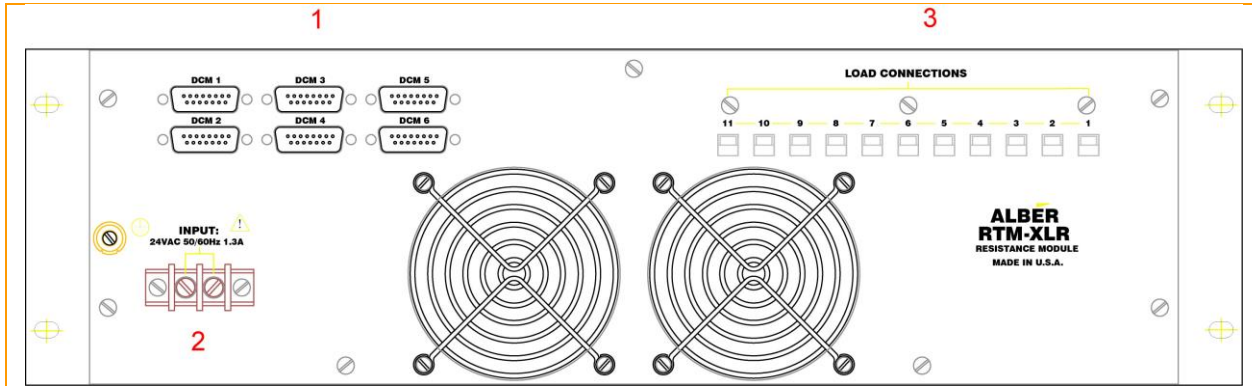

Figure 56. RTM-XLR Rear Panel Connectors

- | | |
|---------------------------------|----------------------------------------------|
| 1. DCM 1 TO 6 | Ports for DCM communication |
| 2. INPUT 24VAC 50/60HZ AC POWER | Power input |
| 3. LOAD CONNECTIONS 1 TO 11 | Provide load to the batteries when activated |

6.8 BDS-256XL External Power Supply

6.8.1 Front Panel Indicators

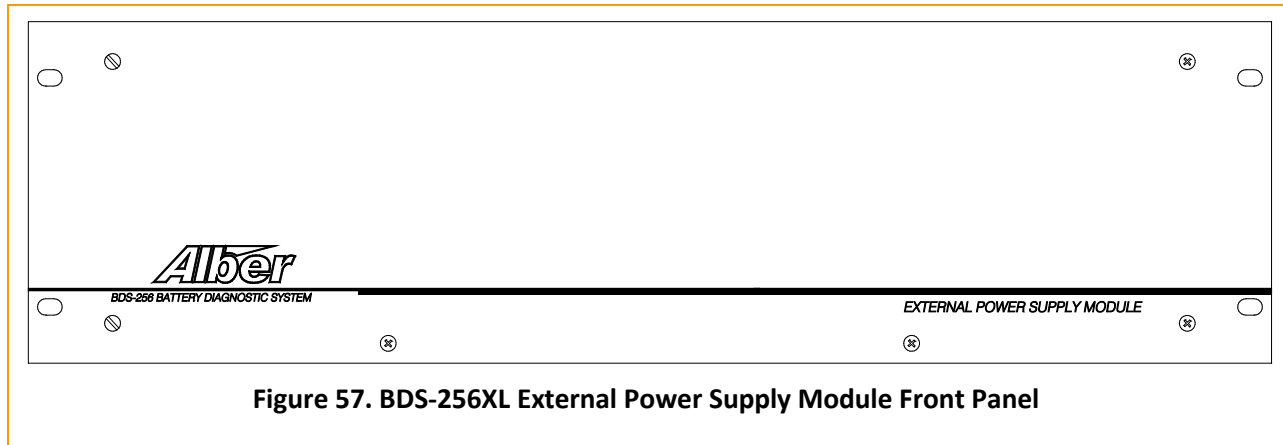
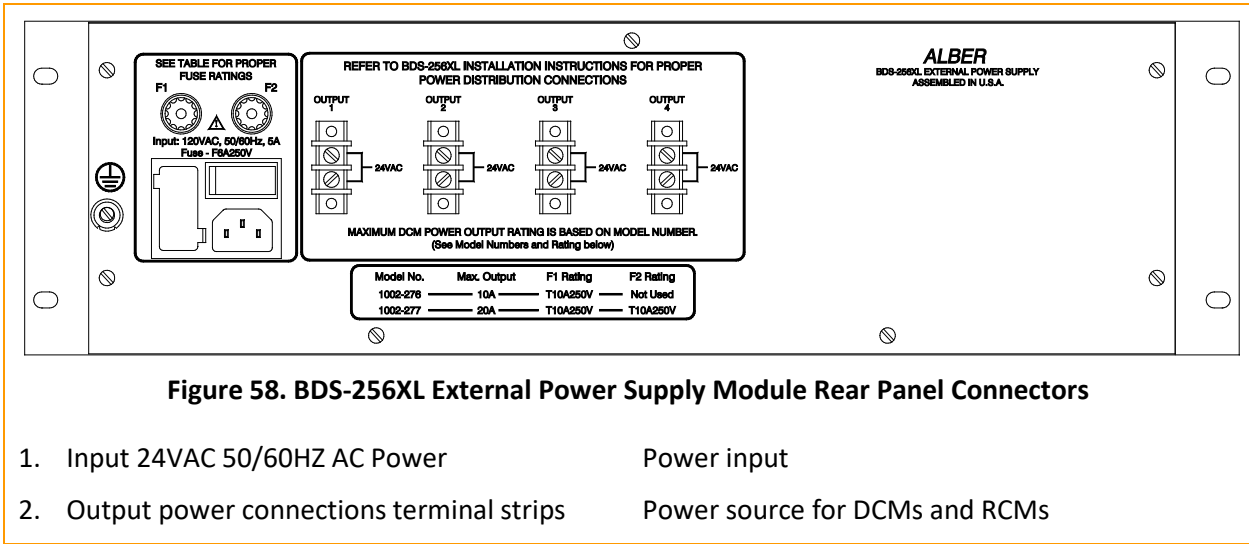

Figure 57. BDS-256XL External Power Supply Module Front Panel

Rear Panel Connectors



6.8.2 Fuses

T10A250V 2 user replaceable fuses. Values based on model number. See table below.

F1 and F2 Fuse Ratings Table*			
Model Number	Max Output	Fuse F1 Rating	Fuse F2 Rating
1002-276	10A	T10A250V	Not Used
1002-277	20A	T10A250V	T10A250V

6.10

6.11 Specifications

6.11.1 BDS–256XL System Specifications

6.11.1.1 Inputs

- ◆ Cell voltage:
1V (NICAD)
2V,
4V,
6V,
8V,
12V, and
16V ranges
- ◆ 5 intertier resistance channels per DCM.
Optional 6 DCMs total, with 15 intertiers per string.
- ◆ String voltage.
- ◆ 10 (maximum) temperature channels.* 2 per DCM
- ◆ Discharge current.*
- ◆ Float current.*
- ◆ 16 digital inputs (Optional).

*Optional temperature and current transducers are required. Optional temperature transducer can be contact type or immersible.

6.11.1.2 Outputs

Eight control outputs from the Controller (Optional)

6.11.1.3 Parameters / Features

Number of cell channels: Up to 8 strings of 256 cells per string
 Up to 6 DCM–XL48d's units per string

6.11.1.4 Measurement Range / Tolerances

Intertier resistance:	0 to 5mΩ, 5% of reading ±5μΩ		
	1V range	0–2V	0.1% ±1mV
	2V range	0–4V	0.1% ±1mV
	4V range	0–8V	0.1% ±2mV
Cell voltage:	6V range	0–8.5V	0.1% ±2mV
	8V range	0–10V	0.1% ±10mV
	12V range	0–16V	0.1% ±10mV
	16V range	0–20V	0.1% ±10mV
Cell resistance:	0 to 32,000μΩ, 5% of reading ±1μΩ		
Intercell Resistance:	0 to 500μΩ, 0.25% of reading ±5μΩ Optional harness and relay modifications required.		
String Voltage:	0 to 80.00 volts, ±0.2% of reading ±0.02 volts 0 to 400.0 volts, ±0.2% of reading ±0.1 volts 0 to 600.0 volts, ±0.2% of reading ±0.2 volts		
*Discharge Current:	0 to 4000A ±5% full scale		
*Float Current:	0 to 5000mA ±50mA		
*Temperature:	0°C to 80°C (32°F to 176°F), ±1°C.		
*Optional Current Transducer CT required. Transducer accuracy affects overall current/temperature reading accuracy.			

6.11.1.5 Operating Environment

- ◆ Temperature range: 5°C to 40°C
41°F to 104°F
- ◆ Humidity range: 0% to 80% RH (non condensing) at 5°C to 31°C
0% to 50% RH (non condensing) at 32°C to 40°C
- ◆ Indoor use only
- ◆ Installation category II
- ◆ Pollution degree 2
- ◆ Altitude 0 to 2000 meters above sea level



WARNING:

A BDS–256XL Discrete Reading system, comprising of a CM–XL8 Controller, DCM–XL48d's, and RTM–XLR Resistance Test Modules, may be mounted in a 19" wide rack enclosure. If using such a rack enclosure, be certain it is properly earth grounded and adequate ventilation is provided to prevent equipment from overheating. The receptacle for the AC cord from the cabinet must have protective earth connection, three prong plug. Never defeat the use of the earth connection prong.

6.11.2 Cabinet Specifications

The BDS–256XL Discrete Reading system consists of:

1. CM–XL8 Controller Module,
2. DCM–XL48d Discrete Reading Data Collection Modules DCMs, and
3. RTM–XLR Resistance Test Modules RTMs.
4. Supplemental power module (configuration dependent)

The operating environment described on this page applies to these units as well.

6.11.2.1 Power

- ◆ 115VAC \pm 10% 60Hz,
12 amps maximum.

6.11.2.2 Model

Part number 1100–262, where the computer, monitor, UPS, Controller, DCM, and Resistance Test Module may be mounted within as required.

6.11.2.3 Maximum Dimensions

24" wide x 26" high x 37" deep with folding keyboard tray down

6.11.2.4 Installation Requirements

Only equipment that is part of the BDS system should be installed in the BDS cabinet.

The 4 corners of the cabinet must be securely bolted to the floor.

6.11.2.5 Operating Environment

- ◆ Temperature range: 5°C to 40°C
41°F to 104°F
- ◆ Humidity range: 0% to 80% RH (non condensing) at 5°C to 31°C
0% to 50% RH (non condensing) at 32°C to 40°C
- ◆ Indoor use only
- ◆ Installation category II
- ◆ Pollution degree 2
- ◆ Altitude 0 to 2000 meters above sea level

**WARNING:**

A BDS–256XL Discrete Reading system, comprising of a CM–XL8 Controller, DCM–XL48d's, and RTM–XLR Resistance Test Modules, may be mounted in a 19" wide rack enclosure. If using such a rack enclosure, be certain it is properly earth grounded. The receptacle for the AC cord from the cabinet must have protective earth connection (three prong). You must not defeat the use of the earth connection prong.

6.11.3 CM–XL8 Controller Specifications**6.11.3.1 Power**

115VAC/230VAC $\pm 10\%$ 60Hz,

5 amps maximum for a configuration of 8 strings of 256 cells

6.11.3.2 Fuses

- ◆ One 500mA SB and one 2A SB
On PC board.
Not user replaceable.
- ◆ Fuse #1 and #2
Rear panel.
For values, please refer to the model number description tables in section 1.3 Model Number on page 8.
- ◆ One 5A for 115VAC or
2.5A for 230VAC, ABC or equivalent.
AC power block–rear panel.

6.11.3.3 Inputs

- ◆ Remote alarm reset.
User–supplied 12V signal, 15mA maximum
Momentarily applying voltage initiates the reset action
- ◆ Digital input (optional). Sixteen 12V, 15mA maximum.
For monitoring external dry contacts.

6.11.3.4 Outputs

- ◆ 24VAC power for up to four DCMs and Resistance Test Modules.
- ◆ Alarm contacts.
2 Form C, 2A at 30VDC.
One for critical alarm; one for maintenance alarm.
- ◆ User programmable relay contacts (Optional).
Eight Form C, 2A at 30VDC
- ◆ LEDs (one each):
(G)REEN DCM TX transmit,
(G)REEN DCM RX receive,
(G)REEN com port,
(G)REEN status,
(R)ED critical alarm,
(Y)ELLOW maintenance alarm, and
(G)REEN resistance test.

6.11.3.5 Communication

- ◆ Modbus protocol, ASCII, and SNMP to PC, Vertiv proprietary to DCMs.

- ◆ Local port, USB connector–front panel
- ◆ Local port, RS–232 DB–9 connector–rear panel
- ◆ LAN port, RJ–45–optional–rear panel
- ◆ RJ–11 Telco line, internal 14.4Kbs modem–rear panel
- ◆ Fiber optic ports–DCM communication link

6.11.3.6 Data Storage

- ◆ SRAM 8 MB nonvolatile memory for all configuration settings and data
- ◆ Flash memory for firmware upgrades

6.11.3.7 Control Switches

- ◆ Power on/off:
Main DCM–XL48d power switch on rear panel of CM–XL8 Controller module.
Rocker switch.
- ◆ Alarm reset:
Alarm Reset switch on front panel of CM–XL8 Controller module.
Momentary push button.

6.11.3.8 Tolerances

Tolerances are described in the BDS–256XL Systems Specifications section 6.8.1.4 Measurement Range / Tolerances on page 29.

6.11.3.9 Packaging

19" rack mount

6.11.3.10 Dimensions

- ◆ 19"W x 8"D x 5"H
- ◆ 16 lbs

6.11.3.11 Agencies

- ◆ UL listed. File number E212234
- ◆ CE approved

6.11.4 DCM–XL48d Specifications

6.11.4.1 Power

- ◆ 24VAC \pm 10%,
450mA maximum

6.11.4.2 Fuses

- ◆ One 0.5A SB and one 0.75A SB
On PC board
Not user replaceable

6.11.4.3 Inputs Rear Panel

- ◆ 48 cell voltage channels
- ◆ 5 intertier channels
- ◆ 2 temperature channels
Optional temperature transducer required
- ◆ One discharge current channel
Optional current transducer required
- ◆ One overall voltage channel (Optional)

6.11.4.4 Outputs Front Panel

- ◆ LEDs (one each):
(G)REEN DCM TX transmit,
(G)REEN DCM RX receive,
(G)REEN status, and
(G)REEN poll

6.11.4.5 Outputs Rear Panel

- ◆ +15VDC, –15VDC power output (Optional) for discharge current transducer
- ◆ Resistance Test Module control cable output

6.11.4.6 Combined Input / Output Connectors Rear Panel

- ◆ 24VAC
- ◆ 2 fiber optic ports

6.11.4.7 Communications

- ◆ Fiber optic
Vertiv proprietary.

6.11.4.8 Data Storage

- ◆ E² nonvolatile memory for setup
- ◆ Flash memory for firmware upgrade

6.11.4.9 Control Switches Rear Panel

- ◆ Reset switch
- ◆ DCM addressing: PC board mounted DIP switches in DCM

6.11.4.10 Tolerances

Tolerances are described in the BDS–256XL Systems Specifications section 6.8.1.4 Measurement Range / Tolerances on page 29.

6.11.4.11 Packaging

19" rack mount

6.11.4.12 Dimensions

- ◆ 19"W x 10"D x 1.75"H
- ◆ 6 lbs

6.11.4.13 Agencies

- ◆ UL listed. File number E212234
- ◆ CE approved

6.11.5 RTM–XLR Resistance Test Module Specifications

6.11.5.1 Power

- ◆ 24VAC ±10%,
1A maximum

6.11.5.2 Fuses

- ◆ Two 0.5A SB
On PC board
Not user replaceable

6.11.5.3 Inputs–Rear Panel

- ◆ One 24VAC

- ◆ 6 load control cable connectors for DCM 1 to DCM 6
- ◆ 11 load connections

6.11.5.4 Outputs–Front Panel

- ◆ LEDs (one each):
(G)REEN power and
(R)ED service

6.11.5.5 Tolerances

Tolerances are described in the BDS–256XL Systems Specifications section 6.8.1.4 Measurement Range / Tolerances on page 29.

6.11.5.6 Packaging

19" rack mount

6.11.5.7 Dimensions

- ◆ 19"W x 12"D x 5"H
- ◆ 16 lbs

6.11.5.8 Agencies

- ◆ UL listed. File number E212234
- ◆ CE approved



WARNING:

Only install equipment that is part of the BDS system into the BDS cabinet.

6.11.5.9 Wiring



WARNING:

The BDS system is designed to connect to UPS systems that are 600VDC or less and a maximum of 300V with respect to earth ground. You must verify the voltage with respect to earth ground before connecting the system. Do this by measuring the voltage from each battery post referenced to earth ground. The voltage cannot exceed 300V. Do not defeat the use of the earth connection prong.

A BDS–256XL system, which includes a CM–XL8 Controller Module, DCM–XL48d Data Collection Module, and RTM–XLR Resistance Test Modules, may be mounted in a 19" wide rack in a cabinet. If using a cabinet, you must ground the cabinet and installed equipment. The cabinet has several ground lugs, of which at least one must be connected to earth ground.

The DCM and Resistance Test Module have protective earth grounding connections that you must connect to earth ground using 10AWG copper wire.

The receptacle for the AC cord from the cabinet must have protective earth connection (three prong).

When connecting equipment via modem to a telephone line, use a minimum 26AWG TELCO line cord.

NOTE:

Drawings in this manual may be for reference only or superseded by later drawings. For the latest information, refer to the drawings supplied with your system.

7 Before System Installation

7.1 Required Drawings

IMPORTANT NOTE:

The following drawings are required for BDS–256XL Discrete Reading system installation. The drawings in this manual may not be the most recent revision and are included for reference only. Refer to the Engineering Drawing Package included with your system for the necessary drawings.

Title	Number
Example Drawing #1 and Example #2	
Quick Connect Sense / Load Leads, BDS	BDS–123–A380
Temperature Connections	BDS–136–A397
Quick Connect Post Clip Leads, BDS	BDS–163–A424
600V Fused Load Lead, BDS	BDS–193–A453
Overall Voltage Cable	BDS–1116–A479
Current Transducer/Float Connections DCM–XL48d	BDS–1470–A811
Current Transducer Connections DCM–XL48d	BDS–1132–A501
Fabrication Detail, Resistor Lead Assembly, BDS	BDS–1251–A640
General Assembly, RTM–XLR, Resistance Test Module	BDS–1277–B1202
General Assembly, CM–XL8, Controller	BDS–1278–B1203
General Assembly, DCM–XL48d, Data Collection Module	BDS–1280–B1205

Figure 59. Drawings

7.2 System Configuration

The BDS–256XL can accommodate virtually any battery configuration. The following list describes the more commonly used BDS–256XL configurations.

Configuration	Description
BDS–256–1x98x1	1 string of 98–1v cells in series
BDS–256–1x104x1	1 string of 104–1v cells in series
BDS–256–1X58X2	1 string of 58–2v cells in series
BDS–256–1x108x2	1 string of 108–2v cells in series
BDS–256–1x122x2	1 string of 122–2v cells in series
BDS–256–1x180x2	1 string of 180–2v cells in series
BDS–256–1x182x2	1 string of 182–2v cells in series

<i>Configuration</i>	<i>Description</i>
BDS-256-1x184x2	1 string of 184-2v cells in series
BDS-256-1x188x2	1 string of 188-2v cells in series
BDS-256-1x192x2	1 string of 192-2v cells in series
BDS-256-1X198X2	1 string of 198-2v cells in series
BDS-256-1x210x2	1 string of 210-2v cells in series
BDS-256-1x216x2	1 string of 216-2v cells in series
BDS-256-1X220X2	1 string of 220-2v cells in series
BDS-256-1x232x2	1 string of 232-2v cells in series
BDS-256-1x234x2	1 string of 234-2v cells in series
BDS-256-1x236x2	1 string of 236-2v cells in series
BDS-256-1x238x2	1 string of 238-2v cells in series
BDS-256-1x239x2	1 string of 239-2v cells in series
BDS-256-1x240x2	1 string of 240-2v cells in series
BDS-256-1x241x2	1 string of 241-2v cells in series
BDS-256-1x244x2	1 string of 244-2v cells in series
BDS-256-1x246x2	1 string of 246-2v cells in series
BDS-256-1x252x2	1 string of 252-2v cells in series
BDS-256-1x89x4	1 string of 89-4v modules in series
BDS-256-1x90x4	1 string of 90-4v modules in series
BDS-256-1x120x4	1 string of 120-4v modules in series
BDS-256-1x121x4	1 string of 121-4v modules in series
BDS-256-1x122x4	1 string of 122-4v modules in series
BDS-256-1x123x4	1 string of 123-4v modules in series
BDS-256-1x60x6	1 string of 60-6v modules in series
BDS-256-1x64x6	1 string of 64-6v modules in series
BDS-256-1x78x6	1 string of 78-6v modules in series
BDS-256-1x80x6	1 string of 80-6v modules in series
BDS-256-1x81x6	1 string of 81-6v modules in series
BDS-256-1x60x8	1 string of 60-8v modules in series
BDS-256-1x61x8	1 string of 61-8v modules in series
BDS-256-1x16x12	1 string of 16-12v modules in series
BDS-256-1x27x12	1 string of 27-12v modules in series
BDS-256-1x30x12	1 string of 30-12v modules in series

Configuration	Description
BDS-256-1x31x12	1 string of 31-12v modules in series
BDS-256-1x32x12	1 string of 32-12v modules in series
BDS-256-1x33x12	1 string of 33-12v modules in series
BDS-256-1x34x12	1 string of 34-12v modules in series
BDS-256-1x36x12	1 string of 36-12v modules in series
BDS-256-1x40x12	1 string of 40-12v modules in series
BDS-256-1x42x12	1 string of 42-12v modules in series
BDS-256-1x18x16	1 string of 18-16v modules in series
BDS-256-1x20x16	1 string of 20-16v modules in series
BDS-256-1x21x16	1 string of 21-16v modules in series
BDS-256-1x24x16	1 string of 24-16v modules in series
BDS-256-1x27x16	1 string of 27-16v modules in series
BDS-256-1x30x16	1 string of 30-16v modules in series

Figure 60. BDS-256XL Configuration Options

7.3 Location Consideration

Vertiv creates a customer drawing package that contains a system drawing with site specific information. Refer to this package and verify all components are available before starting installation.

7.3.1 Power



WARNING:

Do not energize the cabinet or any component with battery voltage until after the installation is complete.

The electrical service required is less than 15A at 115VAC or 7.5A at 230VAC.

7.3.2 Physical Mounting

If using a computer and cabinet, place the cabinet where it will be permanently mounted. Keep the back of the cabinet accessible for servicing. Prepare the computer and cabinet, if included, and the Controller. This includes unpacking, mounting, and connecting the modules.

7.3.2.1 Ballast For Cabinet

Fill the container at the bottom of the cabinet with ballast. This provides stability to help prevent the cabinet from tipping over. The recommended ballast is all-purpose sand (Sure-Mix® All Purpose Sand or equivalent) available at most home improvement stores.

7.3.2.2 Cabinet Wiring/UPS

Pass the AC power cord for the power strip mounted inside the cabinet through the lower left hole and plug it into a UPS-protected outlet once installation is complete. If using an internally

mounted Uninterruptible Power Supply UPS, plug the power strip AC cord into the UPS, pass the UPS power cord through the hole, and plug it into an AC outlet once installation is complete.

7.3.3 Check Service Access

Mount the DCMs close to the battery, making sure they are accessible for servicing.

7.3.4 Maximum Wire And Cable Lengths

Install an insulated wire tray along the length of each battery tier, making sure it does not interfere with cell replacement. Install the sense leads, test current leads, 24VAC cable, and run wires and fiber optic cable.

The maximum length for each sense lead, resistance test cable, and external load control cable is 100 feet (≈ 30.5 meters). The resistance test cable maximum length is configuration dependent. If the length exceeds 100 feet degradation or reduced test current could occur.

7.3.5 AC Power Distribution

To simplify installation, the input power connections on the DCM/RTM facilitate daisy chain connections. This can be done with the following constraints.

- The DCMs and RTM associated with each string in the battery should have the 24V AC power cord “home run” back to the controller, no daisy chaining between multiple strings.
- In string configurations with a large number of DCMs (4 or greater) and the distance to the controller is greater ($> 75'$), it is advisable to split up the power distribution in the string between two power cords to reduce line losses.

7.3.6 Fiber Optic Cable And DCM Communication Information

The DCMs communicate with the Controller via fiber optic cable and form a communication ring network.

NOTE:

The maximum length of standard plastic fiber optic cable that may be used is 250 feet or 76 meters.

Transmit TX/FO on the Controller connects to Receive RX/FO on a DCM. Transmit on this DCM connects to Receive on the next DCM, and so on until Transmit on the last DCM returns to Receive on the Controller.

IMPORTANT NOTE:

Unlike the requirement for connecting DCMs to battery strings, the string and address assignments on the DCM nameplates do not determine the order in which DCMs are connected within the fiber optic ring.

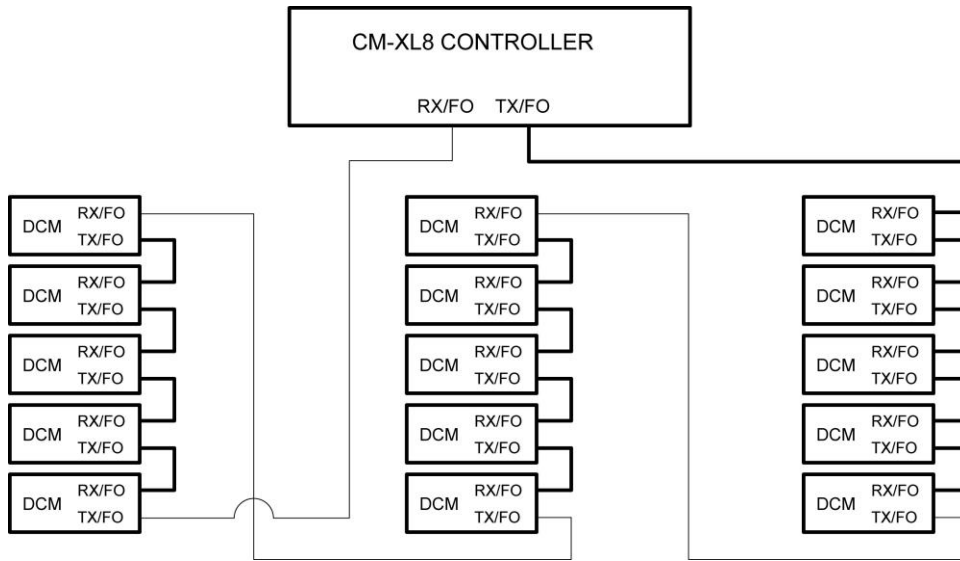

Figure 61. DCM Fiber Optic Connections

When using fiber optic cable, locate the cabinet so the fiber optic cable run does not exceed 250 feet or 76 meters from the Controller to the DCM. Look at the system drawing and the physical facility and determine how the fiber optic and power cables to the DCMs should exit the cabinet. Two 1½" holes, through which wires may be passed, are on the left side of the cabinet. When installing the fiber optic cable, do not bend the cable in a radius tighter than 35mm.

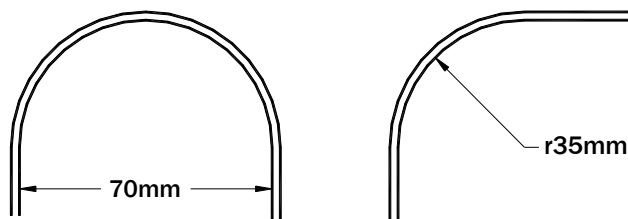

Diagram Not To Scale

Figure 62. Minimum Bend Radius Of Fiber Optic Cable

7.3.7 Conduit

Conduit can be used to route harnesses from the BDS components to the battery rack and to a wire tray to distribute the wires to each cell.

7.3.8 Panduit

A Panduit (or equivalent) slotted cable tray with cover is normally used to distribute wires to the cells. Suggested slotted cable trays and covers are Panduit E1X1L66 with C1L66, or E5X5L66 with C5L66.

8 Begin System Installation

The following steps are required for system installation.

8.1 Identify and Verify Cells, Markings, Load Steps, Configuration, etc.

1. Identify cell 1.
2. Identify and verify that all cells are marked correctly. Mark if necessary.
3. Verify wire routing, per drawing if provided; (conduit, panduit etc.)



WARNING:

Never route the wires in the same conduit with other wires in the facility. Never run the wires parallel to the battery bus. Some inverters emit large signal spikes that could cause induction problems through the connection cables.

4. Identify load step connections.
5. Double-check the configuration by referring to the drawings provided with the system.



WARNING:

Check the configuration before installation. If the wrong configuration is installed onto the battery, the unit could be permanently damaged.

8.2 Fit Tab Washers

Fit tab washers per drawings provided with the system and manual. Remember to place extra tab washers for load steps and intertiers if applicable. Refer to Installation Details drawing BDS-123-A380 for more detailed connection information.

8.3 Voltage Sense Lead Connection Preparation



WARNING:

Before making any connections to the battery, verify the fuses have been removed from the fuse holders. Do not install the fuses until the time that the entire system is commissioned.

In hazardous voltage applications where battery voltage is greater than 60VDC, remove the load cable fuse before disconnecting the load cable connector from the Resistance Test Module.

NOTE:

Each wire must have a 10K Ω flameproof resistor with the same construction as the voltage sense lead.

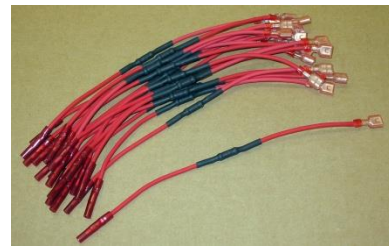

Figure 63. BDS Flex Resist W/Butt Splice-10K Ω Flameproof

Begin assembling the 10K resistor to the sense leads by stripping the wire first, approximately 1/4".

NOTE:

We have chosen a white/brown/orange wire here for demonstration purposes.



Figure 64. Strip Sense Lead Wire

Next, place the stripped wire into the 10K resistor assembly.

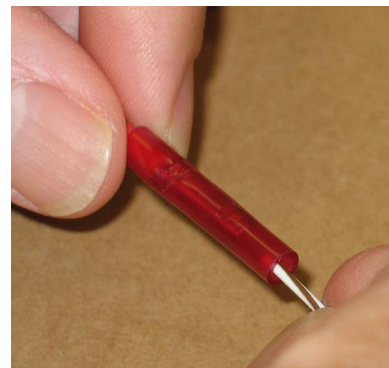

Figure 65. Insert Sense Lead Wire

Into 10K Resistor Assembly

Place the sense lead and insulated section of the 10K resistor into the first die of the Panduit crimper, making sure that the intersection is centered within the die.

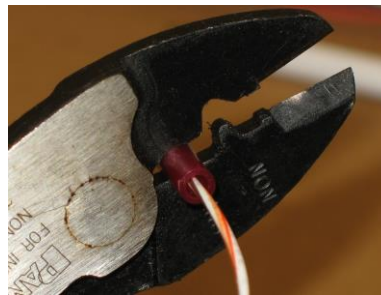

Figure 66. Crimping With Panduit Crimper

Now, crimp once and turn 90° and crimp again.

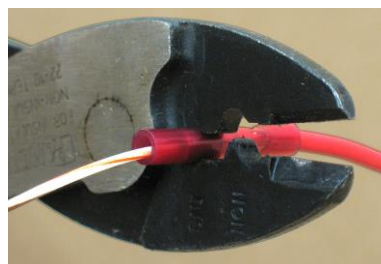

Figure 67. Crimping 10k Resistor Assembly To Sense Lead

Check the crimped connection to make sure it holds well.



Figure 68. Checking 10K Resistor And Sense Lead Connection

Place sense lead and resistor close to its final destination to be connected later.



CAUTION:

When a load lead wire connects to the same point as a voltage sense lead, the load lead wire must be the closest to the cell's post. See BDS-123-A380 ID Full Washer Quick Connect Sense/Load Leads..

8.4 Step By Step Instructions

Re-check the configuration.

Build each load lead wire using BDS-193-A453 Fuse Protected Load Lead, observing length restrictions. A snapshot of the drawing is located here for convenience. All Drawings are located in the rear of the manual.

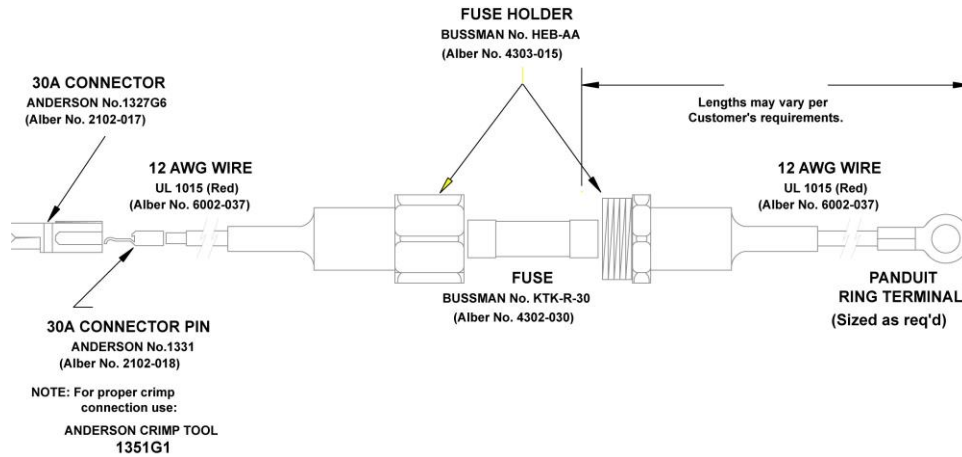

Figure 69. BDS–193–A453 Fuse Protected Load Lead (snapshot)

Choose the desired length of load lead wire.

Strip one end of the 12 AWG load lead wire to $\frac{5}{16}$ ".

For ease of future cell maintenance, leave some slack in the wiring to the cells.



Figure 70. Strip 12 AWG Load Lead Wire

Position the contact into the #30 die.

Center the crimp portion of the contact in the die with the rounded portion of the die up and against the seam on the contact and the tongue of the die directly opposite.

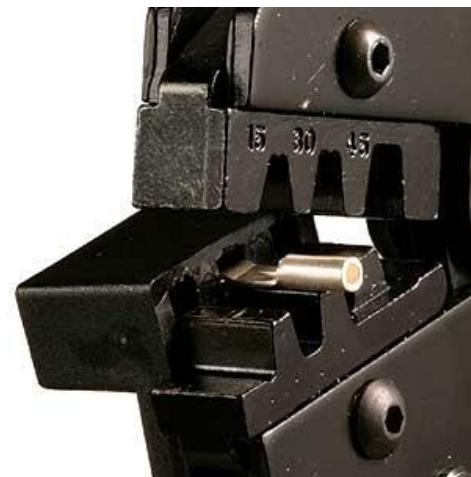

Figure 71. #30 Die With Andersen Contact/Pin

Place the wire inside of the contact pin.

Before crimping the contacts onto the load lead wire, orient the contacts so that the contacts are all facing the correct direction, that is, so they go into the Andersen 30 amp connector/housings without twisting the wire. Notice that the contacts go into the housings one way only.

Double check that the wire is fully inserted into the contact and crimp down firmly.

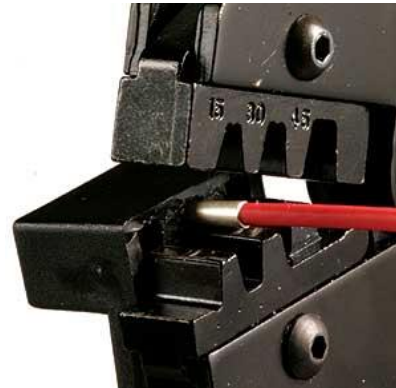

Figure 72. Inserting Load Lead Wire Into Pin To Crimp

Crimp with almost but not quite full force without bottoming out the tool.

Don't spread the connector apart.

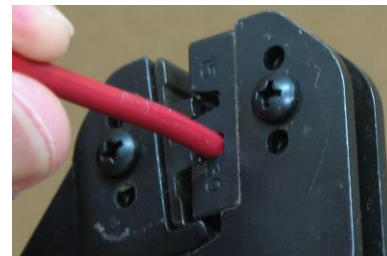

Figure 73. Crimping Load Lead Wire To Pin

A good connection is where the dimensions of the crimped portion are no more than an un-crimped pin. If the crimp is flattened then the pin will not readily push into the housing. Rotate the crimp 90 degrees and squeeze it again in the number three die but this time not as firmly. The idea is to make the width of the crimp just slightly less than it was prior to crimping.



Figure 74. Good Crimp

Assemble the black plastic Andersen connectors/housings together. Put the connector housings together before inserting the connector pins. The plastic housings are held together with dovetail joints. Always slide these joints together! Notice that they slide together in one direction only.



Figure 75. Andersen Connectors Together

**WARNING:**

Always slide the Andersen connectors together and notice that they slide together in one direction only. Do not snap the housings together or apart as damage may occur.

Insert the contacts with their sharp edge down against the flat spring within the housing. The contacts should slide in and click.

If an audible click is not heard then they are not fully seated, the contacts need to be seated/fixed. When inserted fully the contact and its wire "float" slightly inside its housing. If it feels tight it may not be snapped in fully or the contact is wider than it originally was during crimping.

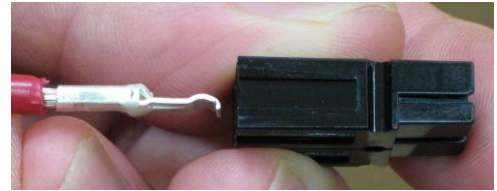

Figure 76. Insert Andersen Contact Into Andersen Connector

Tug slightly on the assembled connector to make sure the contacts are locked in place.

If there is trouble locking the contact into the housing, then look at the side profile of the contacts.

It is possible that it may need to be adjusted and/or straightened before inserting it into the housing.

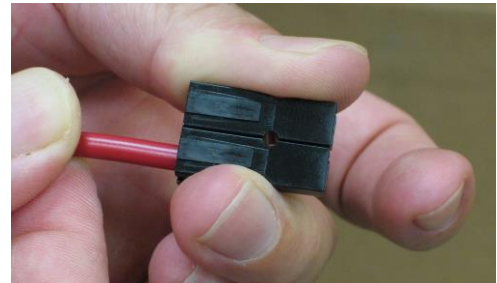

Figure 77. Tug On Assembled Connector

NOTE:

"Measure twice, cut once." The load delivered during a resistance test may be degraded if the load lead wire is too long. Therefore, when building the load lead wires, maintain an overall length from 22 to 90 feet round trip. The maximum length the load lead wires can be is 100 feet. Round trip consists of, for example, a connection from Load Connection 1, out to the battery, and back from the battery to Load Connection 2. If connection length is not maintained, the load will be too low or high, and resistance test results may be affected.



WARNING:

ALWAYS MAKE SURE the polarity is correct before plugging in the equipment. Do not plug in the equipment before checking that all load lead wires have been measured, cut and crimped according to system drawings.

Strip the other end of the inline fuse holder assembly to $\frac{5}{16}$ ".



Figure 78. Strip 12 AWG Load Lead Wire

Choose die C (12 to 10) on the Thomas and Betts crimper.



Figure 79. Thomas And Betts Crimper

Place about 1.5 inches of $\frac{3}{8}$ " heat shrink tubing onto the load lead wire.

Now, secure the open end of the fuse holder on the inline fuse holder assembly into die C.

Then place the load lead wire into the secured inline fuse holder assembly, and crimp.

Turn 90° and crimp again.

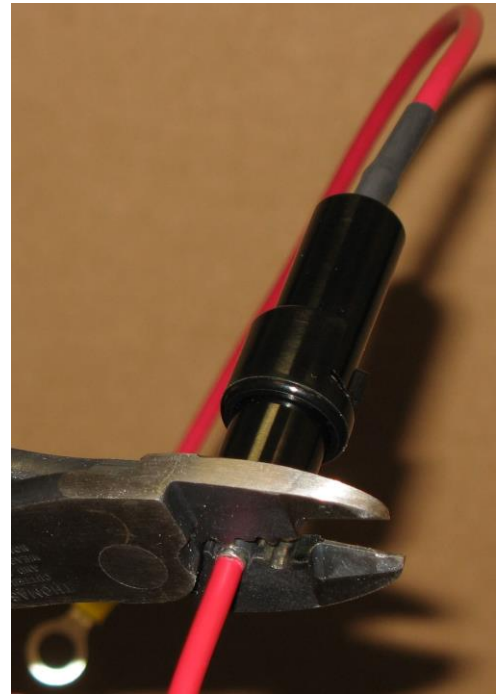

Figure 80. Crimp Fuse holder Onto Inline Fuse holder Assembly

Tug on the connection to make sure the connection will hold well.



Figure 81. Checking Fuse holder/Load Lead Wire Connection

Pull the heat shrink tubing up to cover the wire and the fuse holder connection.

Use a heat source to shrink.

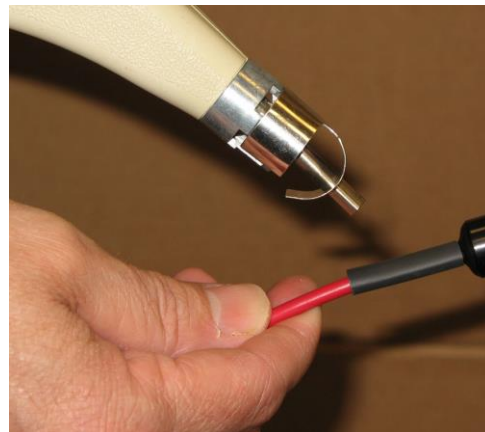

Figure 82. Securing Fuse holder Load Lead Wire Connection With Heat Shrink



CAUTION:

Never wrap excess load lead wire into a coil. A tight coil will result in induction that can adversely affect equipment operation. Leave excess cable in loose, flat lengths.



WARNING:

Before making any connections to the battery, verify the fuses have been removed from the fuse holders. Do not install the fuses until the time that the entire system is commissioned.

In hazardous voltage applications (where battery voltage is greater than 60VDC), remove the load lead wire fuse before disconnecting the load lead wire connector from the BDS.

8.5 Sense Lead Harness Routing from DCMs to the Battery

The installer normally determines the wire routing. Do not route BDS system wires in the same conduit as other wires in the facility. Usually, use a Panduit (or equivalent) slotted cable tray with cover to distribute wires to the cells. Suggested slotted cable trays and covers are Panduit E1X1L66 with C1L66, or E5X5L66 with C5L66.

8.6 Cell Voltage Sense Lead Connections

Voltage sense leads connect from each DCM to the individual cells. Cut each sense lead to the appropriate length and assemble it using drawing BDS-1251-A640. The sense lead resistor assemblies include a 10K 2W 1% flameproof resistor that reduces the risk of a short circuit during installation and maintenance. The DCM to Battery Connections drawing in your drawing package has a schematic of these connections. Properly label each sense lead to simplify the connection process.

When connecting a sense lead to the same battery terminal as the load cable, the load cable must be closest to the cell post. Refer to your copy of BDS-123-A380.

NOTE:

The last sense lead on a DCM connects to the same point as the first sense lead of the next DCM within a battery string. Refer to the DCM to Battery Connections drawing.

Drawings in this manual are for reference only. Use the drawings supplied with your system.

8.7 Intertier Connections

Most battery installations have cables connecting groups of cells on different levels (tiers) within a battery string. Because intertier cables normally have higher resistance than intercell connections, additional sense leads are used to monitor the resistance of these cables. Up to five intertier channels per DCM are provided. The software accommodates up to 15 intertier connections per battery.

**CAUTION:**

The sense leads monitoring an intertier connection must be from the DCM measuring the cell that has its negative post connected to the beginning of the intertier cable.

8.8 Internal Resistance Test Current Cable Connections

Resistance test current cables connect from the Resistance Test Modules to certain cells in the battery string. Cable is supplied based on an average of 35 feet per lead, unless a special length is ordered. Cut the cables to the proper length before termination.

Connect the first resistance test current cable to the positive post of the first cell. The last lead connects to the negative post of the last cell. Other connections depend on the battery configuration.

Refer to the DCM to Battery Connections drawing for a connection diagram. Again, verify fuses are removed from fuse holders before making any battery connections. Refer to your drawings for resistance test current cable construction details. Label each cable at the Resistance Test Module to facilitate servicing.

8.9 Overall Voltage Sense Leads

Connect the Overall Voltage OV sense leads to DCM-1. The OV leads run from the Overall Voltage connector to the most positive and most negative posts of the battery string. Be sure to install 10K 2W 1% flameproof resistors at the battery connection points.

**WARNING:**

Install DCMs so that each DCM connects to the cells to which it is assigned. Each DCM nameplate indicates the battery string number (for multiple string installations) and the position of the DCM within that string.

**CAUTION:**

Do not wrap excess load cable into a coil. A tight coil will result in induction that can adversely affect equipment operation. Leave excess cable in loose, flat lengths.

8.10 Resistance Test Module Control Cable Connections

The Resistance Test Module RTM for each string is controlled by the DCMs assigned to monitor that string. Connect the DCMs and the RTM using the supplied, 15-conductor cable. Connect the cable from the DCM Load Control connectors to the RTM rear panel connectors, starting with connector DCM-1.

8.11 Discharge Current Sensor (Optional)

The BDS-256XL can be used with a magnetic current transducer to measure discharge current. When using a magnetic transducer with 4-conductor shielded cable, connect the Current Transducer connector to the first DCM in the battery string. Refer to BDS-1279-B1205.

8.12 Temperature Sensor (Optional)

Two types of BDS temperature probes are available. One probe hangs free for ambient temperature measurement or mounts on a cell post surface. The other, a Teflon coated probe, may be immersed in a flooded cell.

Using 4-conductor shielded cable, wire the sensors to the DCM connector marked Temperature 1 and 2. Up to ten temperature probes may be used per battery string, and up to two temperature probes may be connected to any DCM associated with that string.

8.13 Float Current Sensor (Optional)

There is one float current sensor channel available. Connect to the DCM rear panel Float Current connector on the first DCM in the battery string. Refer to your copy of BDS-1470-A811 and the Float Charging Current Probe User's Manual for termination details.

We are choosing the Multitel Kit for this manual. Similarities may exist in other float current kits. Multitel's directions are included in this section for convenience.

The following photos are here TO HELP. Please see the FCCP user's guide delivered with the system for possible updates and individual nuances.

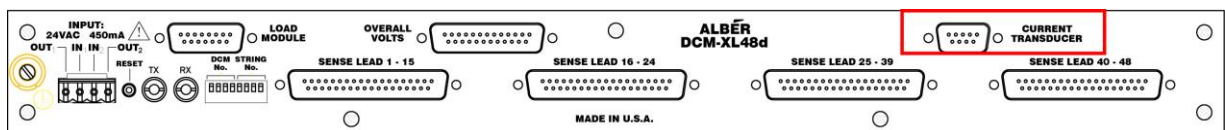

Figure 83. DCM-XL48d Rear Panel Photo From Drawing BDS-1280-B1205



Figure 84. Multitel FCCP Kit pn 5610-053



Figure 85. Float Cable



Figure 86. Multitel FCCP Rear Panel

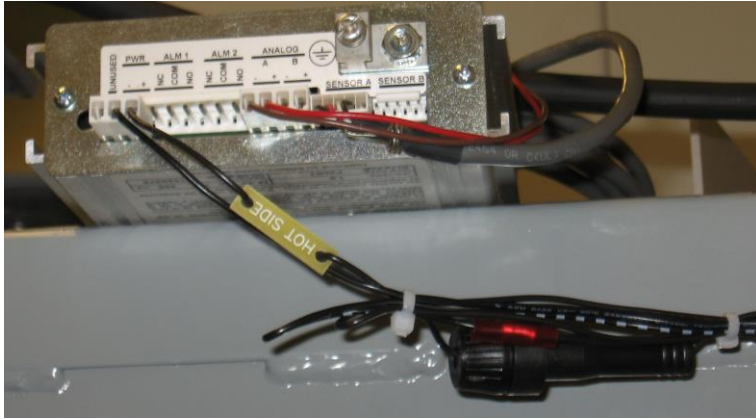

Figure 87. FCCP Connections FCCP



Figure 88. Multitel's FCCP w/ OPTIONAL Power Source And Inline Fuse holder

Figure 5 – Routing the cable

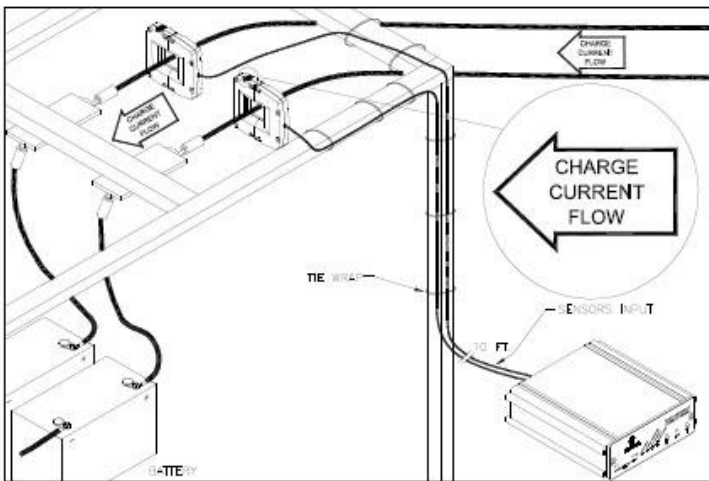

Figure 89. Multitel's FCCP–Routing The Cable

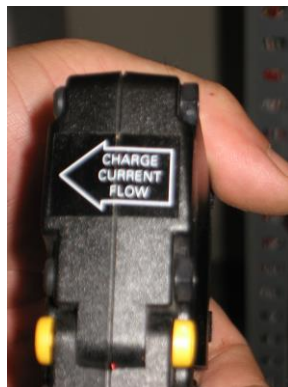

Figure 90. Float Current Sensor

NOTE:

For best results follow the manufacturer's instructions, and please refer to BDS-1470-A811 for FCCP assembly.

Please refer to BDS-1470-A811 for FCCP assembly for termination details and to section 6.3 of Multitel's *Float Charging Current Probe Installation Manual*, displayed here for convenience.

FLOAT CHARGING CURRENT PROBE**INSTALLATION****6.3 WIRING A POWER CABLE TO THE FCCP**

1. Locate the voltage source to power the FCCP control unit. Using a DVM, verify that the voltage difference between the polarities is between 18 and 60 volts DC.
2. Using shielded cable, route from the control unit's mounting location to the located and verified voltage source. If access to the rear of the control unit is restricted, be sure to leave enough cable length to attach the power connector to the rear of the control unit and then to slide the complete assembly into its final installation position. Leave enough cable length to allow connection to the power source.
3. Permanently secure the cable run with cable ties.
4. Install inline fuse holders to the power source end of the shielded cable. The fuses should be as close to the power source as possible. Leave the fuses out of the fuse holder temporarily. Place the fuses somewhere safe where they can be found later.
5. Permanently connect the power source cable to the power source, paying close attention to polarity. Be sure to connect the cable ground to a reliable system ground connection, close to the utilized power source.
6. Turn your attention to the control unit end of the cable. Strip only enough insulation and shield from the cable as necessary to crimp the connector pins and install the connector housing.

NOTE: To maintain the expected FCC emissions, the cable shield needs to come to the base of the connector housing. Therefore, it is critical to only strip away as much insulation as needed to install the connector pins and housing.

Figure 91. Section 6.3 Of Multitel's FCCP Installation Manual Pg. 38

FLOAT CHARGING CURRENT PROBE

INSTALLATION

7. Using the tool, permanently crimp the pins to the wires exposed at the end of the shielded cable to go to the control unit. Slide the crimped wires into the connector housing, making sure to observe the correct polarity and to leave the ground conductor free.
8. Return to the fuse holders and install the fuses temporarily removed earlier.
9. Plug the connector housing into the control unit and verify that the unit becomes active. Remove the connector from the control unit and continue the installation.

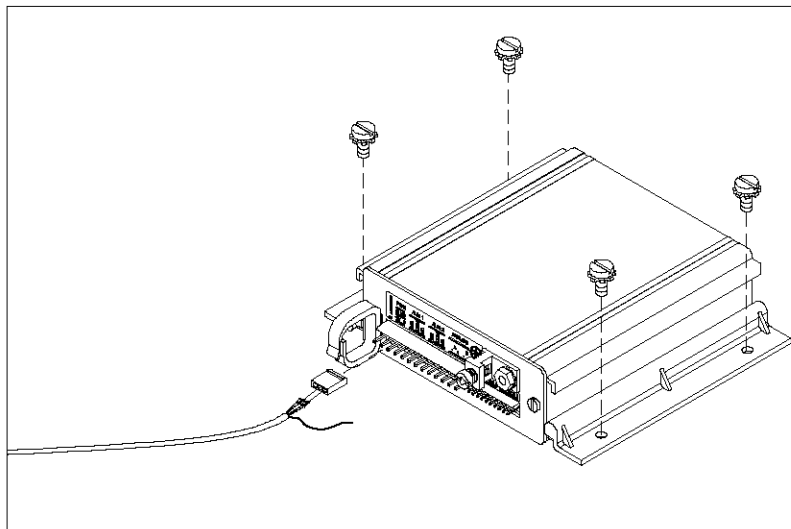

Figure 8 – Inserting the Power Connector

8.1 Power Distribution Connections

To determine the 24VAC power distribution connections for your stationary battery monitoring system, reference Table 2. String and Required DCM Configurations. Look down the String Configuration columns to locate the string configuration for the stationary battery monitoring system. In the column to the right DCMs Required/String, determine the number of DCMs required for the string. Next, look down the first column of Table 3. Power Distribution Connections and find the corresponding row for the number of strings in the system and the number of DCMs per string. Looking across the table row will determine the correct controller and if required the supplemental power module needed to power the system.

- Example 1:** Assume we have 8 strings of 240 2V cells. After locating the 240x2 entry in Table 2. String and Required DCM Configurations, it can be seen that each string requires 5 DCMs. Looking down the first column of Table 3. Power Distribution Connections, we find an entry for 8-5 DCM strings. Looking across this row we can see that neither a 1002-210 or 1002-211 controller can provide sufficient power to support this system, only a 1002-212 controller in conjunction with a 1002-277 supplemental power module will be sufficient to power the system. Additionally, it will show that two strings should be connected to output 1 and 2 terminals of the 1002-212 controller and another two strings to output 3 and 4 terminals of the 1002-212 controller. Two of the four remaining strings should be connected to output 1 and 2 terminals of the 1002-277 supplemental power module and the last two strings connected to output 3 and 4 of the power module as well.
- Example 2:** Assume we have 5 strings of 96 2V cells. After locating the 96x2 entry in Table 2. String and Required DCM Configurations, it can be seen that each string requires 2 DCMs. Looking down the first column of Table 3. Power Distribution Connections, we find an entry for 5-2 DCM strings. Looking across the row we can see that the 1002-210 controller will not support the system. Only a 1002-211 or 1002-212 will work. In addition, the strings can be connected to any of the output terminal blocks.

Note: The DCMs and RTM of any given string can be wired in a daisy-chain fashion with a single 16 gauge pair running to the controller or supplemental power module.

String and Required DCM Configurations											
String Configuration	DCMs Required/String	String Configuration	DCMs Required/String	String Configuration	DCMs Required/String	String Configuration	DCMs Required/String	String Configuration	DCMs Required/String	String Configuration	DCMs Required/String
10X2	1	58x2	2	98x1	3	183x1	4	196x2	5	241x2	6
20X2	1	60x2	2	108x2	3	172x2	4	198x2	5	242x2	6
24X2	1	96x2	2	116x2	3	174x2	4	200x2	5	244x2	6
40x6	1	89x4	2	120x2	3	176x2	4	210x2	5	246x2	6
30x8	1	90x4	2	122x2	3	180x2	4	216x2	5	250x2	6
44x8	1	59x6	2	124x2	3	182x2	4	220x2	5	252x2	6
45x8	1	60x6	2	128x2	3	184x2	4	232x2	5	256x2	6
16x12	1	61x6	2	144x2	3	188x2	4	234x2	5		
25x12	1	64x6	2	116x4	3	192x2	4	236x2	5		
26x12	1	78x6	2	120x4	3			238x2	5		
27x12	1	80x6	2	121x4	3			239x2	5		
30x12	1	81x6	2	122x4	3			240x2	5		
31x12	1	54x8	2	123x4	3						
32x12	1	59x8	2								
33x12	1	60x8	2								
34x12	1	61x8	2								
36x12	1	62x8	2								
39x12	1										
40x12	1										
41x12	1										
42x12	1										
44x12	1										
48x12	1										

Table 2. String and Required DCM Configurations

8.2 Conduit

Optionally, pass conduit through the lower left hole and mount an outlet box inside the cabinet. This must be done by a qualified electrician and meet NEC requirements. Install the remaining components as follows. Please refer to drawing BDS–1278–B1203.

1. If using an optional UPS, install it near the bottom of the rack.
2. Install the computer monitor on the cabinet top shelf.
Connect the power cord to the power strip.
3. Install the computer/PC on the shelf below the video display.
Connect the power cord to the power strip.
4. Connect the monitor to the computer.
5. Install the keyboard in the keyboard drawer and connect it to the computer.
6. If mounting the Controller in the 19" rack, install it below the computer.
Connect an RS–232C cable from the Controller to a COM port on the computer.
Plug the power cord into the power strip.
7. If using a modem to dial out, connect the phone line to the RJ–11 jack on the Controller rear panel. Use a minimum 26AWG TELCO line cord. Please refer to section 5.2 Modem on page 61 for more information on communication connections.
8. If connecting to a LAN, connect the customer–supplied network cable to the RJ–45 connector on the Controller rear panel. Please refer to section 5.5 RJ–45 on page 63 for more information on communication connections.



CAUTION:

Installing the fiber optic and 24 volt power cables from the Controller to the DCMs is the last step.

Do not do this until the DCMs have been physically mounted in place.

8.3 System with No Local Computer

If not using a local computer and cabinet, install the Controller as follows.

1. Provide UPS–protected AC power to the location where each Controller will be installed.
2. Unpack the Controller and, if mounting it in a 19" rack or tower enclosure, install it.
Connect the AC power cord to the UPS protected outlet.
3. If using a modem to dial out, connect the phone line to the RJ–11 jack on the Controller rear panel. Use a minimum 26AWG TELCO line cord. Please refer to section 5.2 Modem on page 61 for more information on communication connections.
4. If connecting to a LAN, connect the customer–supplied network cable to the RJ–45 connector on the Controller rear panel. Please refer to section 5.5 RJ–45 on page 63 for more information on communication connections.



CAUTION:

Installing the fiber optic and 24 volt power cables from the Controller to the DCMs is the last step.

Do not do this until the DCMs have been physically mounted in place.

8.4 System with Local Computer

If using a computer and cabinet, place the cabinet where it will be permanently mounted. If using fiber optic cable, locate the cabinet so the fiber optic cable run does not exceed 250 feet (76 meters) from the Controller to the DCM. Keep the back of the cabinet accessible. Securely anchor the four corners of the cabinet to the floor.

Fill the container at the bottom of the cabinet with ballast. This provides stability to help prevent the cabinet from tipping over. The recommended ballast is all-purpose sand (Sure-Mix® All Purpose Sand or equivalent) available at most home improvement stores.



WARNING:

Do not energize the cabinet or any component with battery voltage until after the installation is complete.

Look at the system drawing and the physical facility and determine how the fiber optic and power cables to the DCMs must exit the cabinet. Two 1½" holes for wire passage are on the left side of the cabinet. Pass the AC power cord for the power strip mounted inside the cabinet through the lower left hole and plug it into a UPS-protected outlet after installation is complete. The electrical service required is less than 15A at 115VAC or 7.5A at 230VAC. If using an internally mounted Uninterruptible Power Supply UPS, plug the power strip AC cord into the UPS, pass the UPS power cord through the hole, and plug it into an AC outlet after installation is complete.

Optionally, pass conduit through the lower left hole and mount an outlet box inside the cabinet. This must be done by a qualified electrician and meet NEC requirements.

Install the remaining components as follows. Refer to your copy of BDS-1278-B1203.

1. If using an optional UPS, install it near the bottom of the rack.
2. Install the computer monitor on the cabinet top shelf. Connect the power cord to the power strip.
3. Install the computer/PC on the shelf below the video display. Connect the power cord to the power strip.
4. Connect the monitor to the computer.
5. Install the keyboard in the keyboard drawer and connect it to the computer.
6. If mounting the Controller in the 19" rack, install it below the computer. Connect an RS-232C cable from the Controller to a COM port on the computer. Plug the power cord into the power strip.
7. If using a modem to dial out, connect the phone line to the RJ-11 jack on the Controller rear panel. Use a minimum 26AWG TELCO line cord.
8. If connecting to a LAN, connect the customer-supplied network cable to the RJ-45 connector on the Controller rear panel.



CAUTION:

Installing the fiber optic and 24 volt power cables from the Controller to the DCMs is the last step.

Do not do this until the DCMs have been physically mounted in place.

8.5 Alarm Contacts and Remote Alarm Reset

There are two sets of Form C alarm contacts, labeled Critical and Maintenance, on the Controller rear panel. Each set of connections has a Common COM, Normally Closed NC, and Normally Open NO terminal.

NOTE:

These alarms are BMDM program configurable under Setup on the Main Menu.

Connection can be made directly to a facility's alarm reporting system. If there is more than one BDS at the same location and only one set of contacts can be monitored, the alarm contacts can be wired in parallel.

The plus and minus remote reset input contacts are on the rear panel of the Controller. Connecting a +12VDC signal to the reset input contacts will reset alarms for all strings.

9 Final Steps Connecting To Battery Terminals

The load lead wire connection and sense lead connection appear in a snapshot here for convenience.

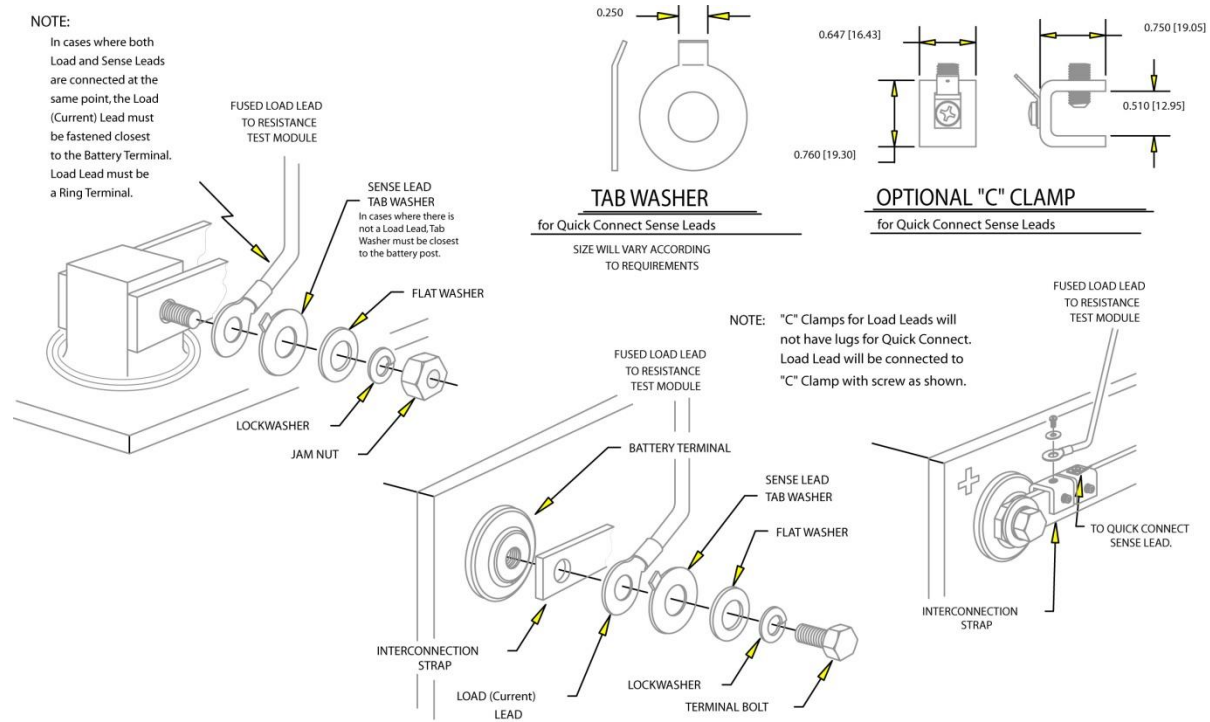

Figure 93. Snapshot BDS-123-A380

Connect the load lead wires to positive posts, except for the last cell, where the connection is to the negative post

10 Final Steps Communication Connections

10.1 Communication Connections

Connection to the BDS can be via:

1. a modem,
2. the USB (front panel CM–XL8)
3. RJ–45 or RS–232 (rear panel CM–XL8).

All methods allow battery parameters to be checked.

10.2 Modem

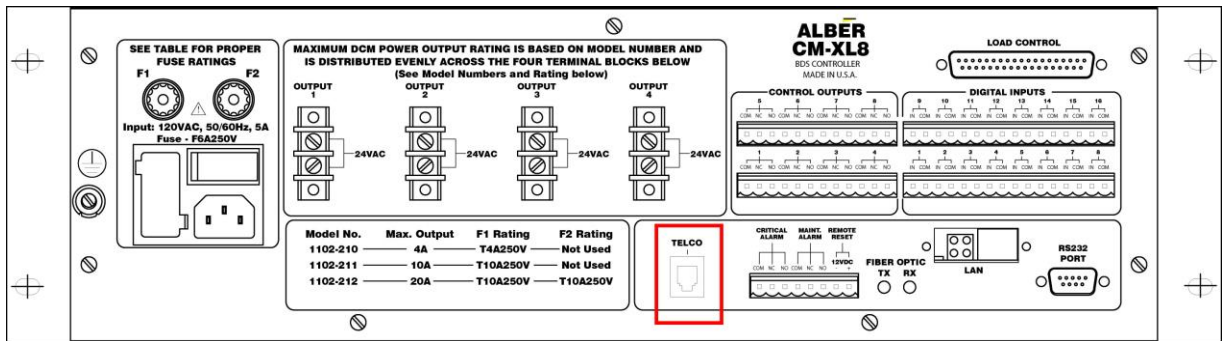

Figure 94. Modem Connection On The Rear Of CM–XL8

The BDS can connect to a telephone line using the **TELCO** RJ–11 connector on the CM–XL8 rear panel. To communicate with a BDS from a remote location, connect the BDS rear panel modem connector to a telephone line. Connect the remote computer’s modem to the telephone line according to the computer manufacturer's instructions.

When connecting via modem, use 26AWG (minimum) **TELCO** line cord. Pins 2 and 3 of the RJ–11 **TELCO** connector are for the tip and ring connection.



Figure 95. TELCO RJ–11 Modem Connection

10.3 USB

Use the front panel USB port for connecting a portable computer for service or data analysis.



Figure 96. USB Cable



Figure 97. Laptop

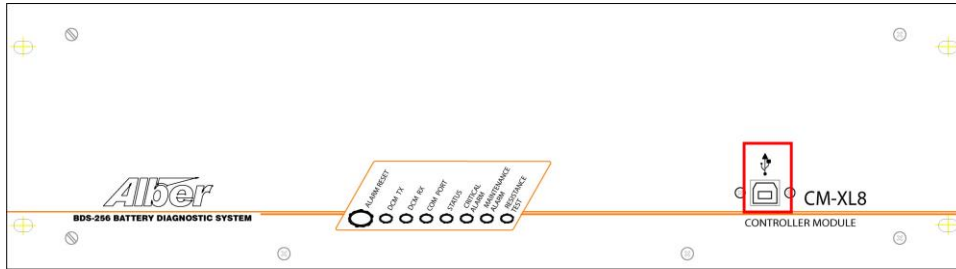

Figure 98. USB Connection CM-XL8 Front Panel

10.4 RS-232

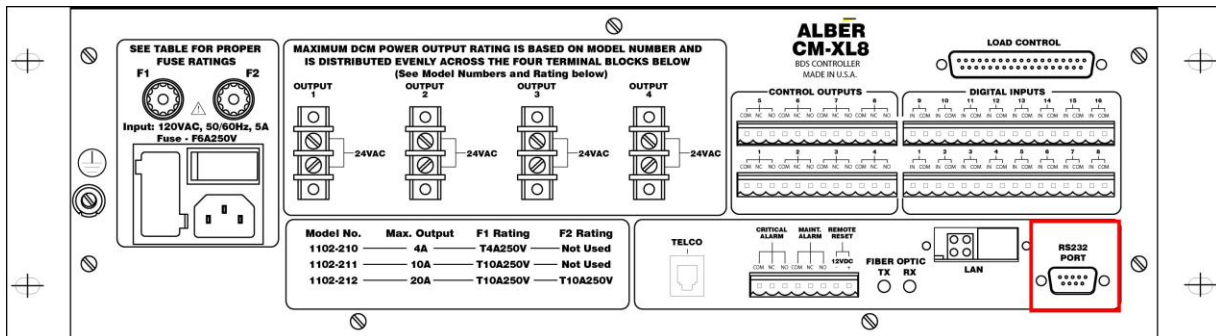

Figure 99. RS-232 Local Port Rear Panel CM-XL8

Use the 9-pin RS-232 Local port on the rear panel of the Controller for connecting to a permanent Local computer or a building management system.

For a permanently connected computer, connect a 9-pin female to female cable (pin to pin construction) to the CM-XL8 rear panel port available and to an available port on the computer to be used.

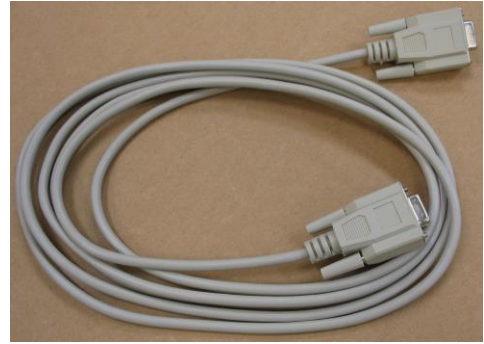

Figure 100. RS-232 9 Pin Female to Female Cable

The connection between the BDS and the computer must not exceed 25 feet.

10.5 RJ-45

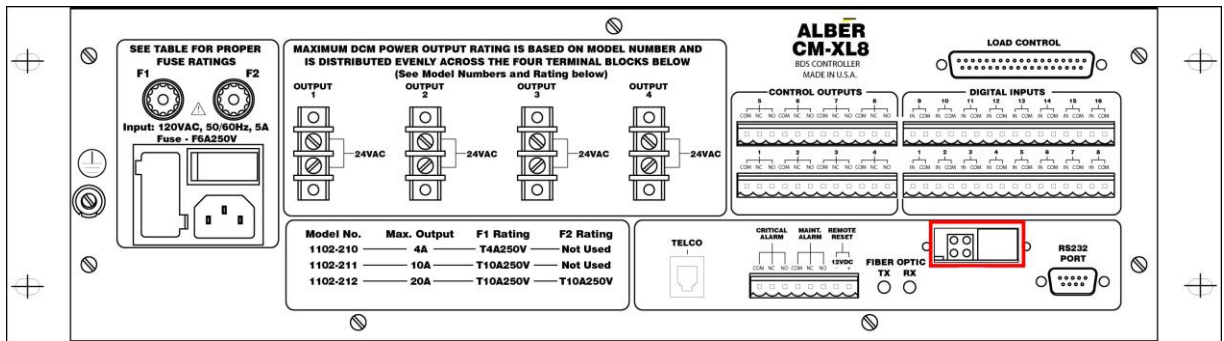

Figure 101. RJ-45 Connection Rear Panel CM-XL8

If the network option is installed, there is an RJ-45 connector installed on the rear panel of the Controller.

Connect an Ethernet patch cable between the controller and the network to be utilized.



Figure 102. RJ-45

11 Drawings

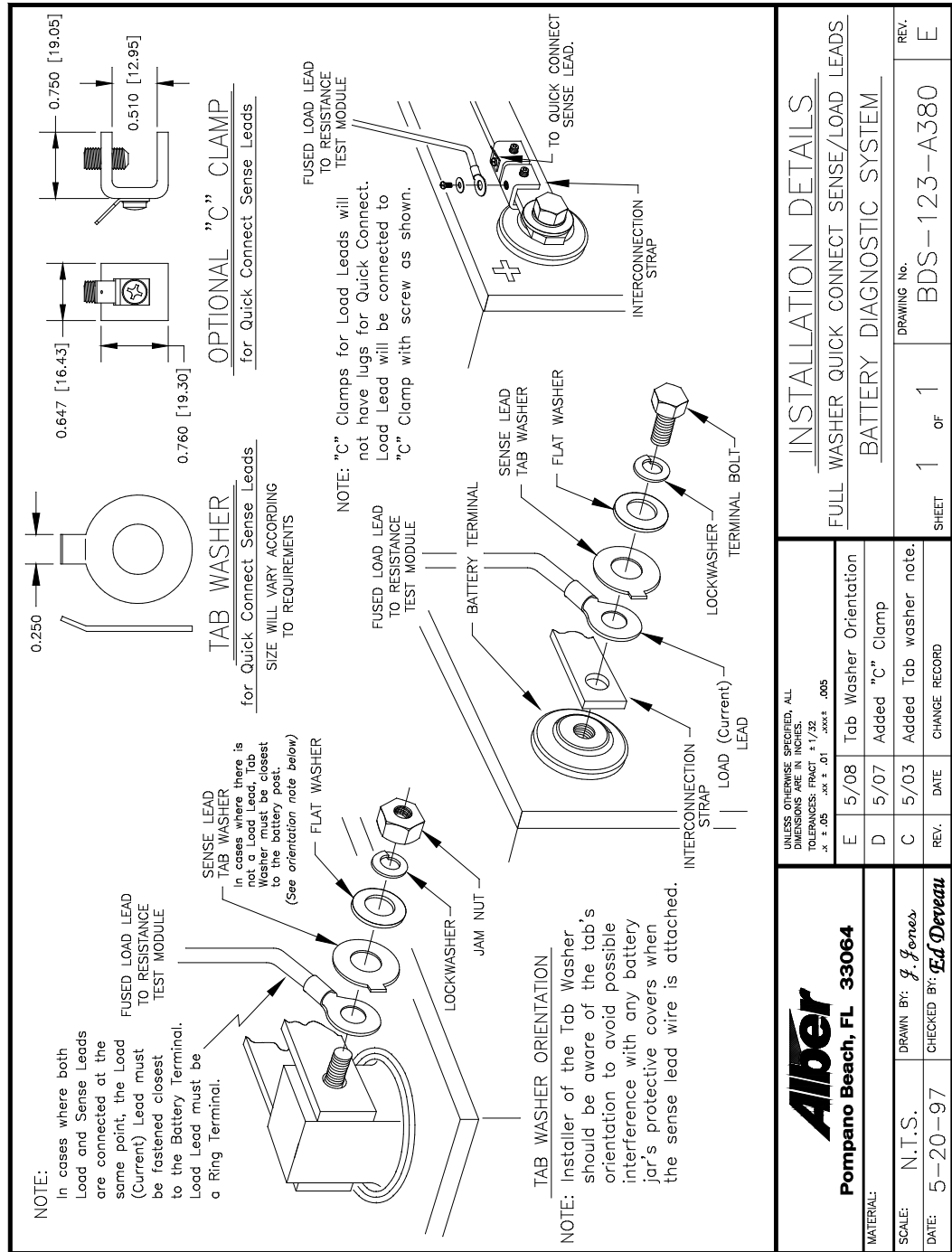

Figure 103. Full Washer Quick Connect Sense/Load Leads

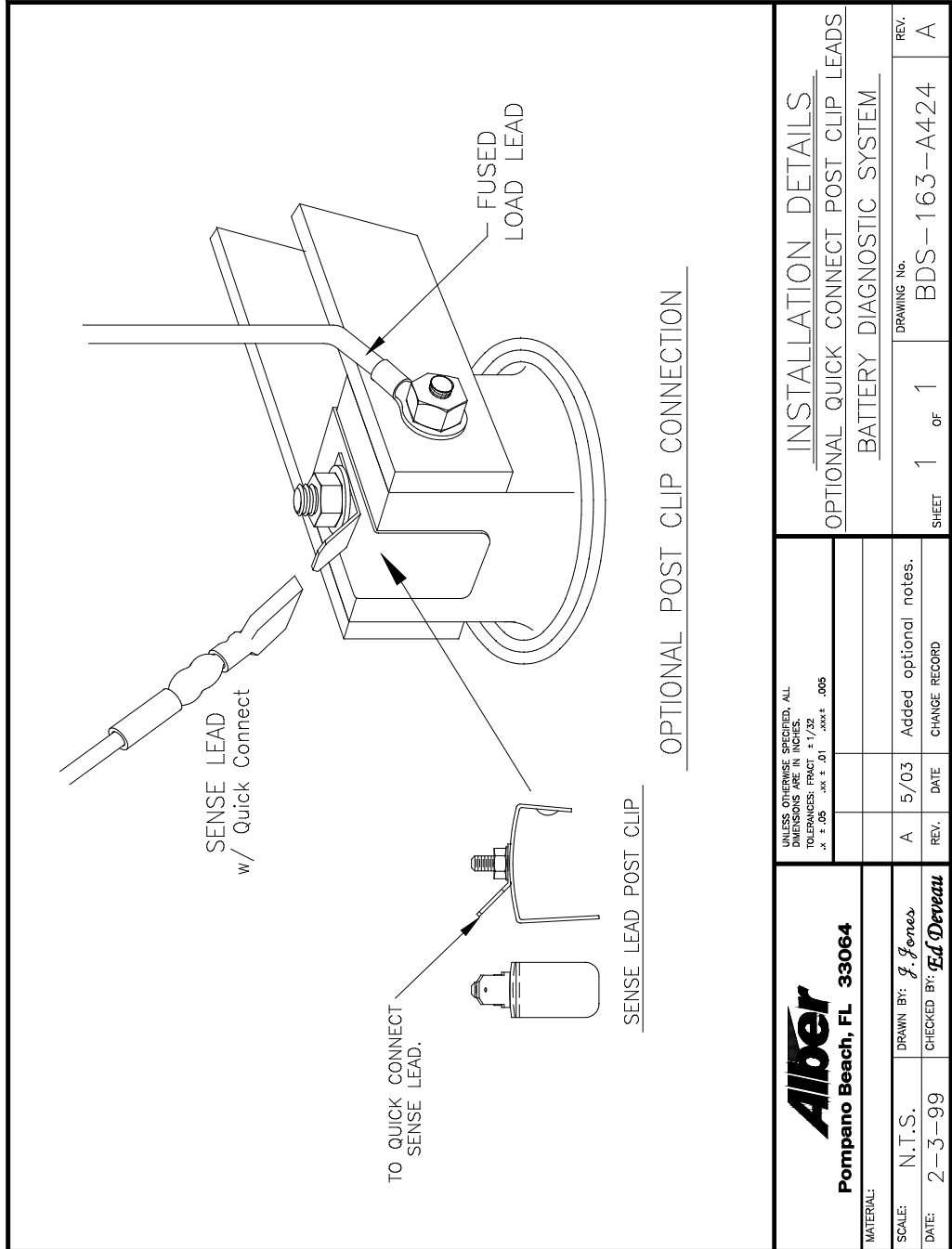

Figure 104. Optional Quick Connect Post Clip Leads

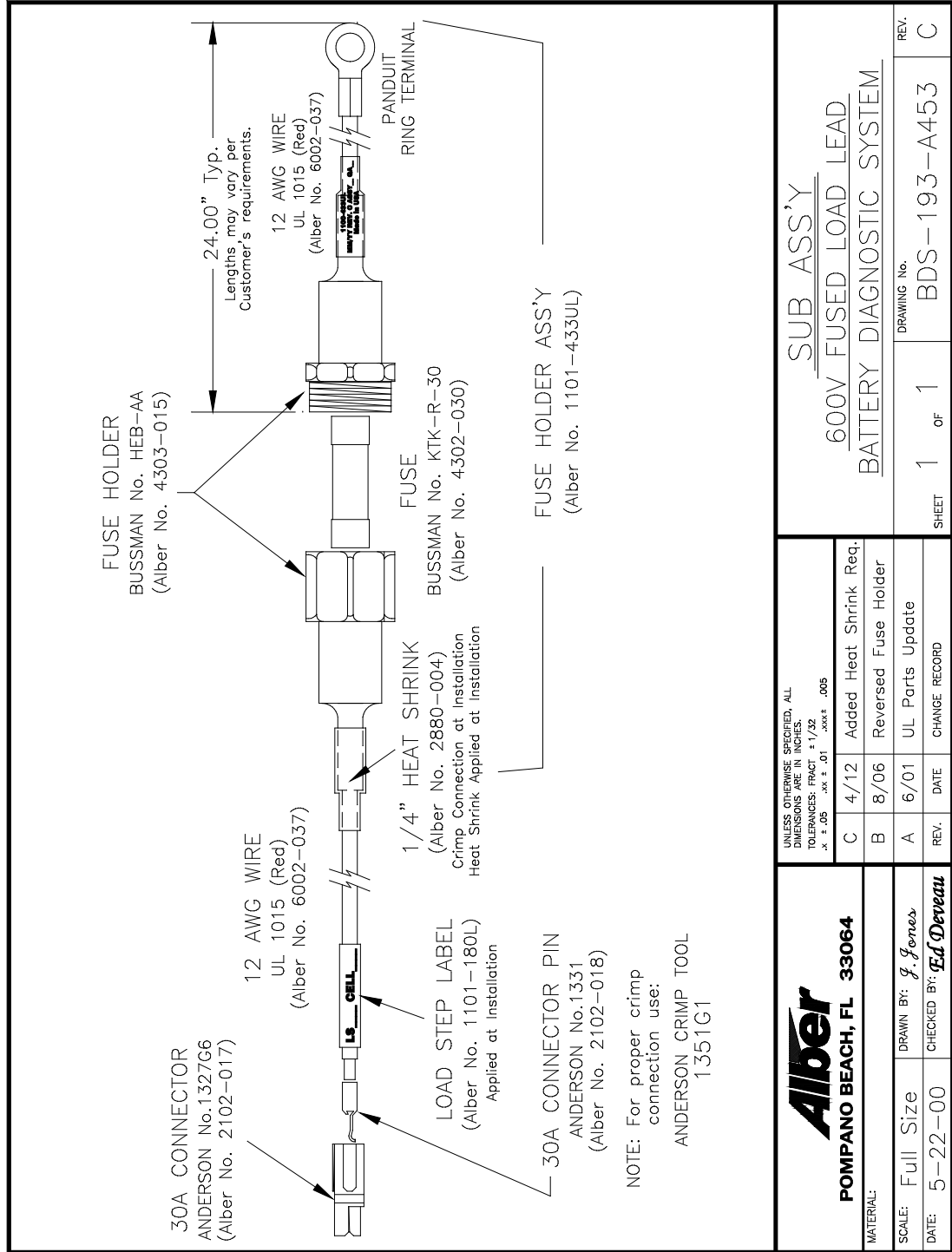

Figure 105. 600V Fused Load Lead

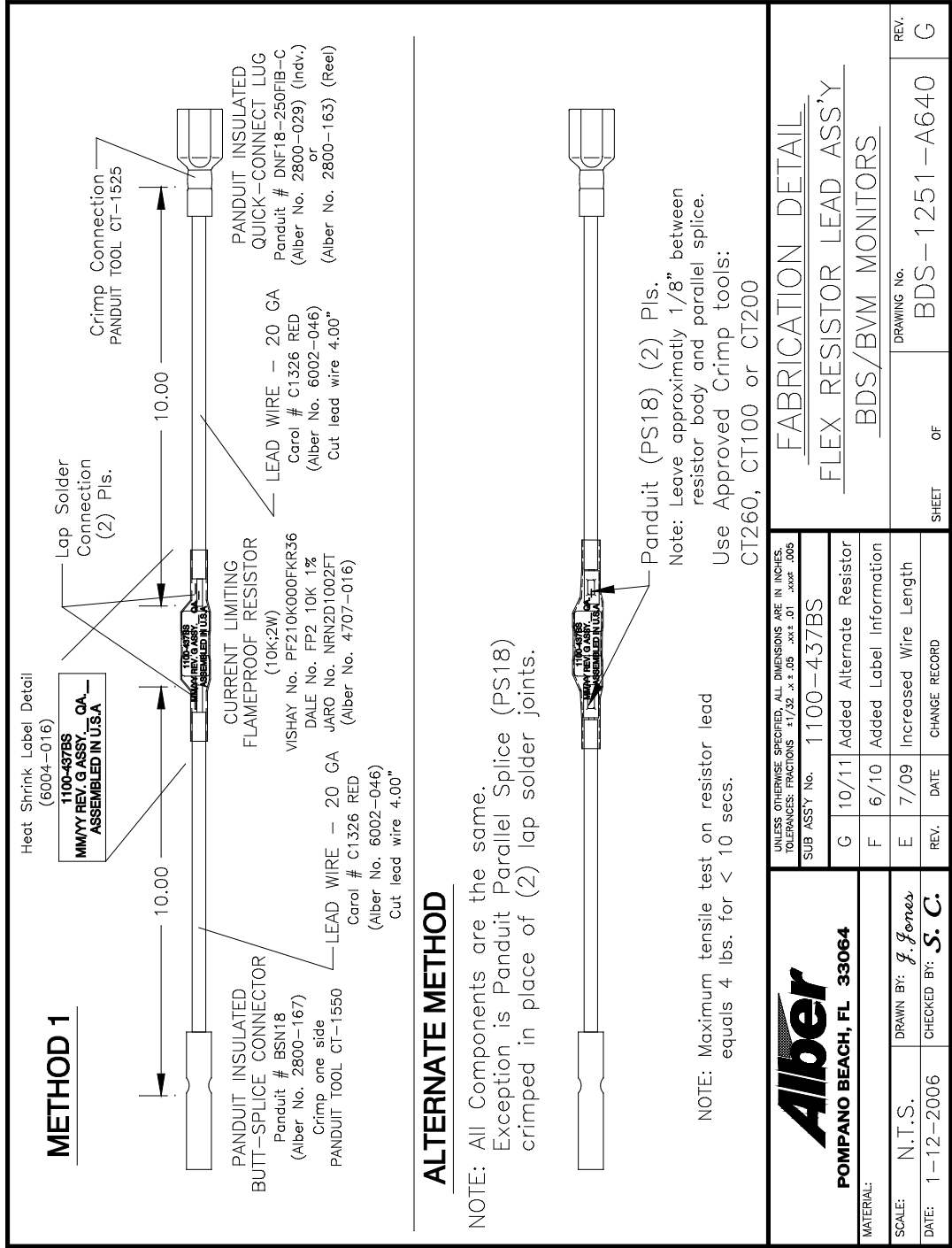

Figure 106. Flex Resistor Lead Assembly

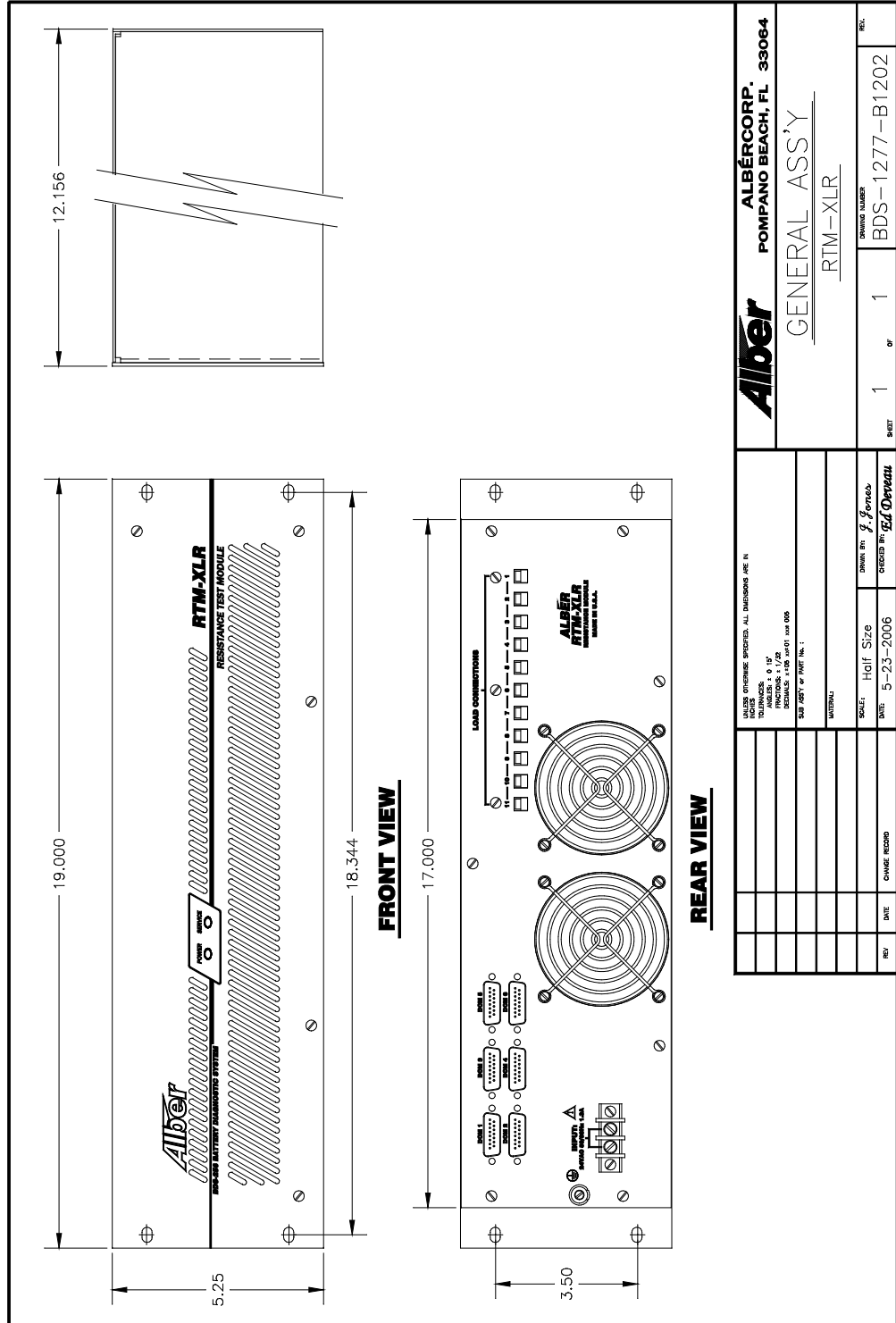

Figure 107. General RTM-XLR Assembly

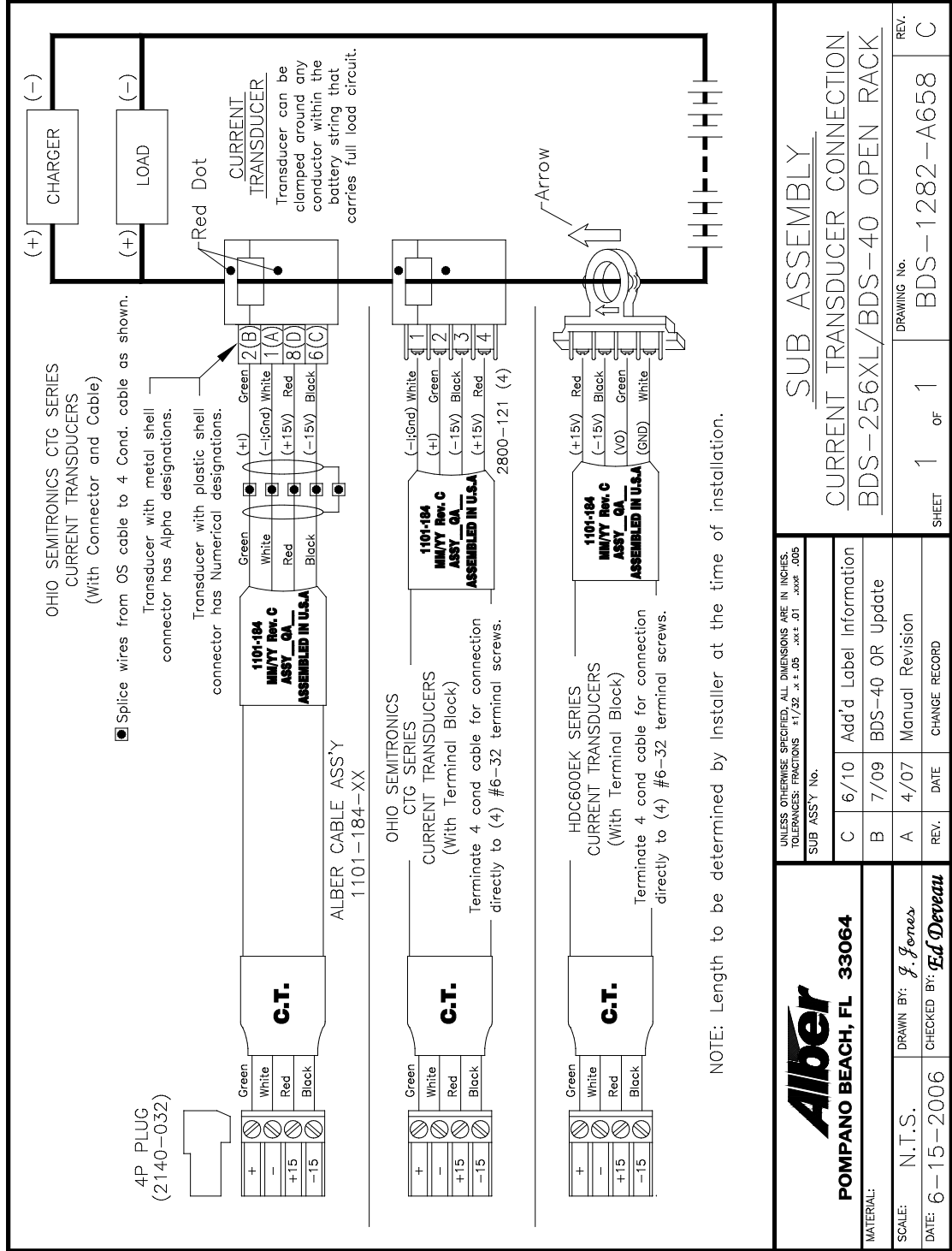

Figure 110. Current Transducer Connection BDS-256XL

<p>POMPANO BEACH, FL 33064</p>		SUB ASSEMBLY	
		CURRENT TRANSDUCER CONNECTION	
MATERIAL:		BDS-256XL/BDS-40 OPEN RACK	
SCALE: N.T.S.	DRAWN BY: J. Jones	SHEET 1 OF 1	REV. C
DATE: 6-15-2006	CHECKED BY: E.D. Deveau	DRAWING No. BDS-1282-A658	REV. C

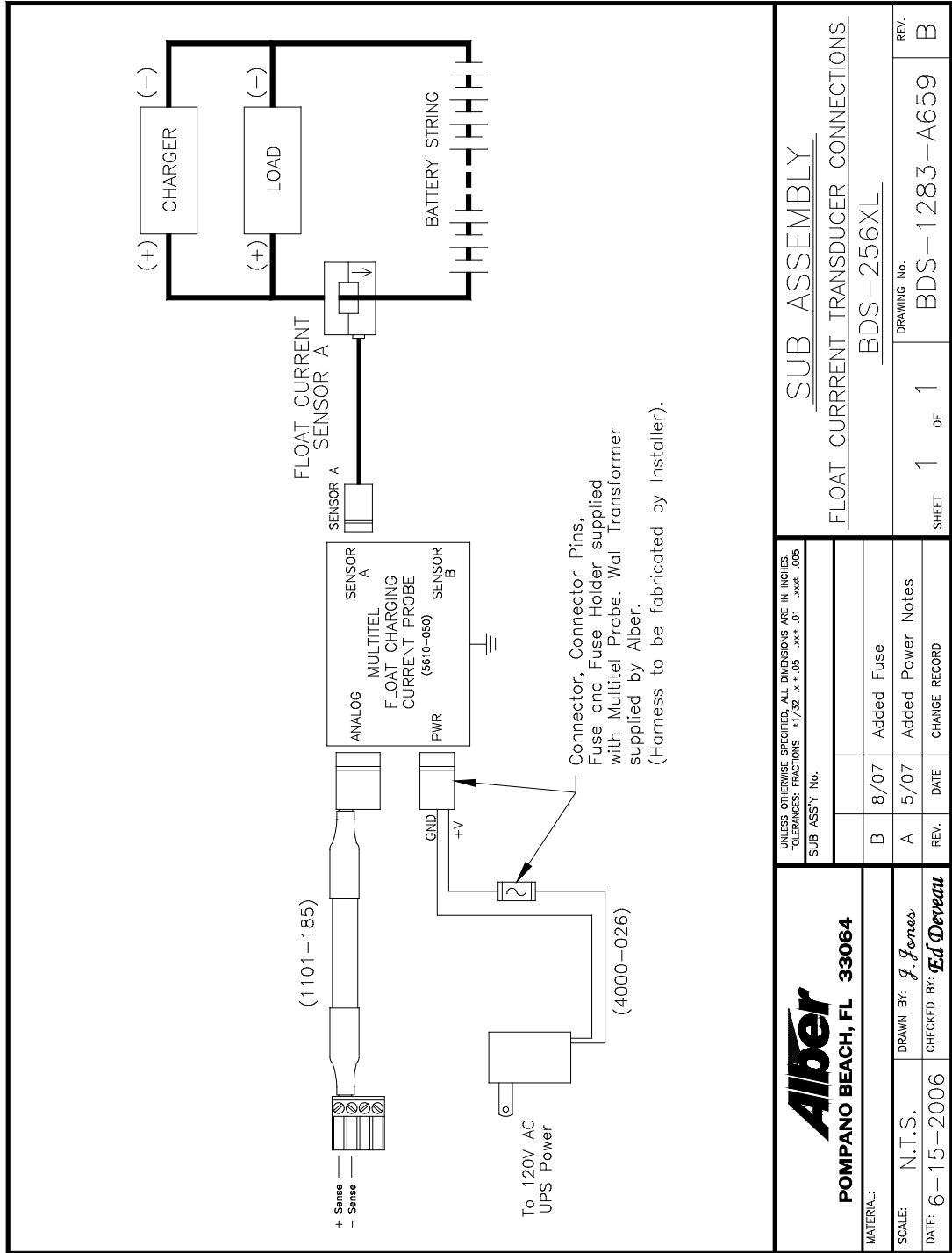

Figure 111. Float Current Transducer Connections

Alber POMPANO BEACH, FL 33064		SUB ASSEMBLY FLOAT CURRENT TRANSDUCER CONNECTIONS BDS-256XL	
UNLESS OTHERWISE SPECIFIED, ALL DIMENSIONS ARE IN INCHES. TOLERANCES: FRACTIONS $\pm 1/32$, $\times \pm .05$, $.xxx \pm .01$, $xxx \pm .005$			
SUB ASS'Y No.			
REV.	DATE	DRAWING No.	REV.
B	8/07	Added Fuse	B
A	5/07	Added Power Notes	B
DATE: 6-15-2006		DRAWING No. BDS-1283-A659	
SCALE: N.T.S.		REV. B	
DRAWN BY: J. Jones		SHEET 1 OF 1	
CHECKED BY: Ed Drevau		DRAWING No. BDS-1283-A659	
		REV. B	

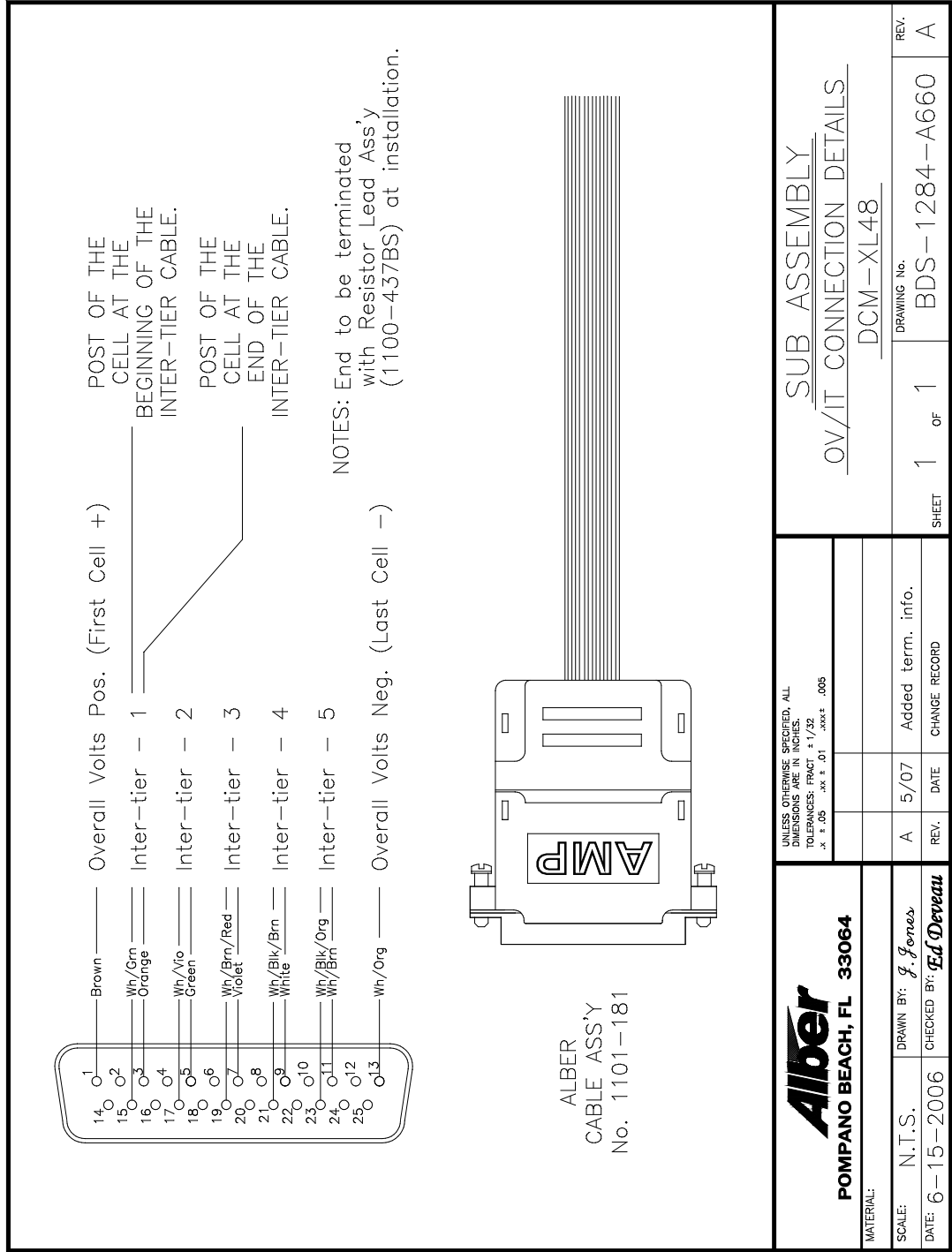

Figure 112. OV/IT Connection Details

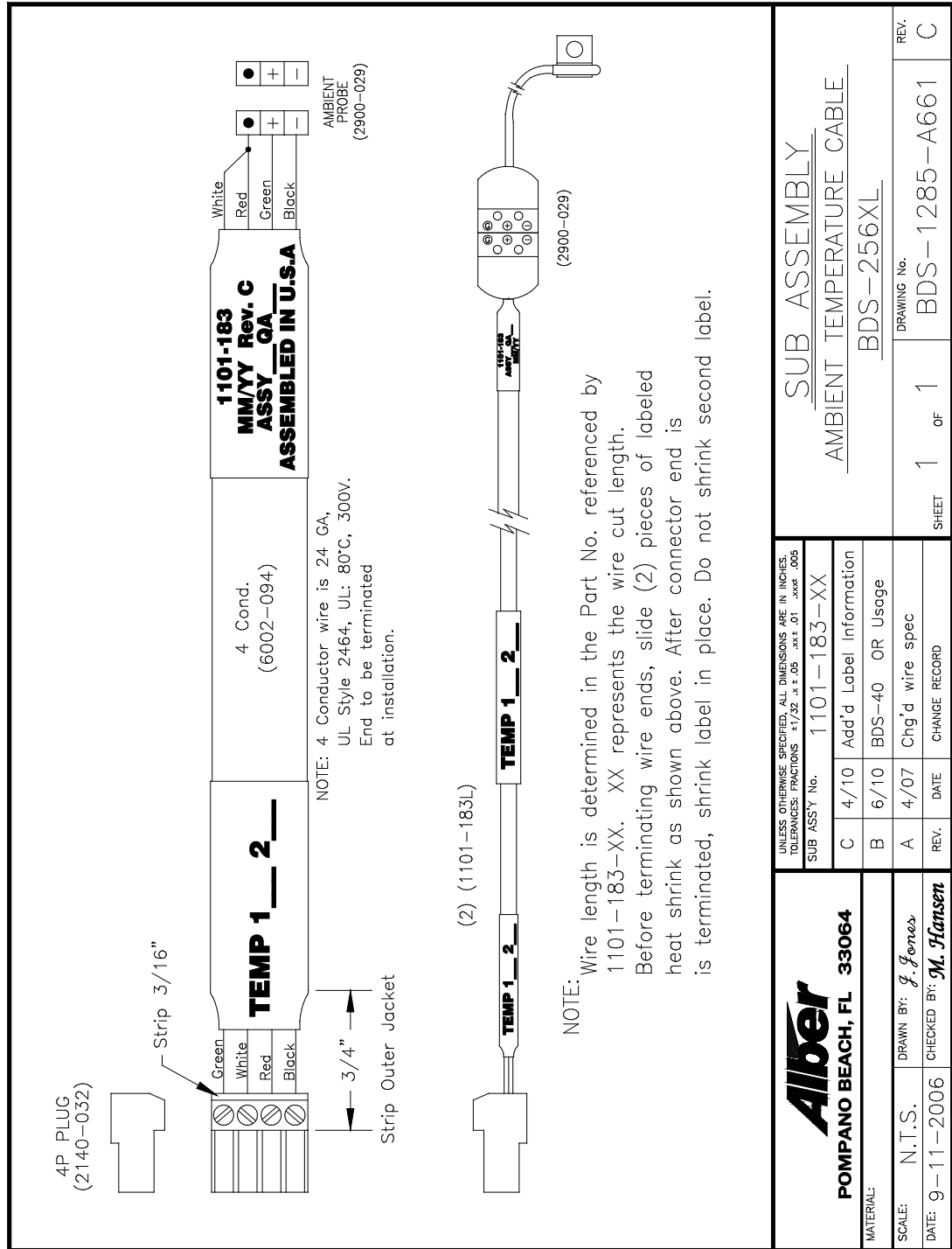

Figure 113. Ambient Temperature Cable

		SUB ASSEMBLY	
		AMBIENT TEMPERATURE CABLE	
POMPANO BEACH, FL 33064		BDS-256XL	
MATERIAL:			
SCALE: N.T.S.	DRAWN BY: J. Jones	DRAWING No. BDS-1285-A661	
DATE: 9-11-2006	CHECKED BY: M. Hansen	SHEET 1 OF 1	REV. C
SUB ASSY No. 1101-183-XX		CHANGE RECORD	
C 4/10	Add'd Label Information		
B 6/10	BDS-40 OR Usage		
A 4/07	Chg'd wire spec		
REV.	DATE	RECORD	

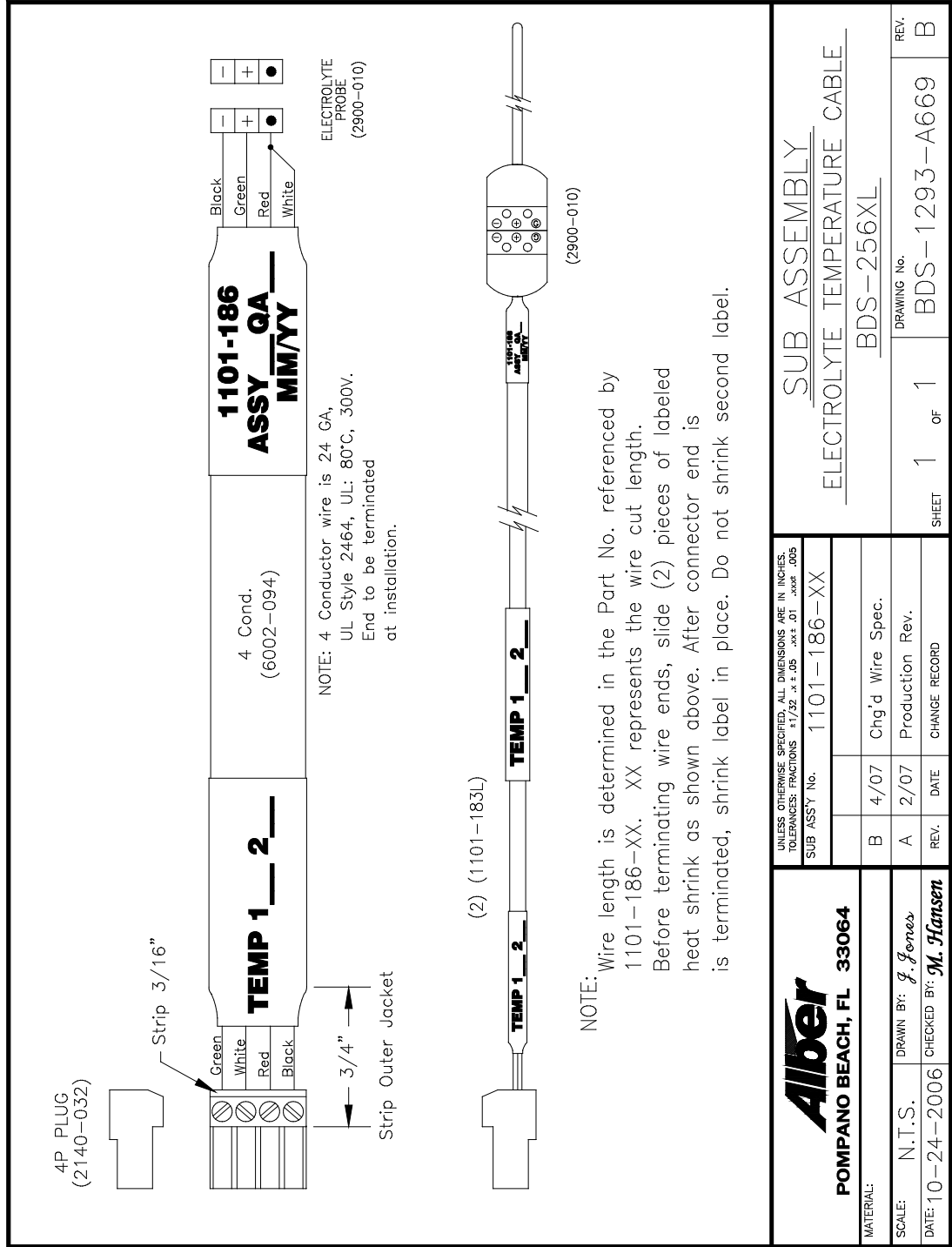

Figure 114. Electrolyte Temperature Cable

Alber POMPANO BEACH, FL 33064 MATERIAL:	SUB ASSEMBLY ELECTROLYTE TEMPERATURE CABLE BDS-256XL	
	SUB ASSY No. 1101-186-XX	UNLESS OTHERWISE SPECIFIED, ALL DIMENSIONS ARE IN INCHES. TOLERANCES: FRACTIONS ±1/32 .x ±.05 .XX ±.01 .XXX ±.005
SCALE: N.T.S. DATE: 10-24-2006	DRAWN BY: <i>J. Jones</i> CHECKED BY: <i>M. Hansen</i>	Chg'd Wire Spec. Production Rev.
REV. A	DATE 2/07	RECORD CHANGE
REV. B	DATE 4/07	RECORD CHANGE
SHEET 1 OF 1	DRAWING No. BDS-1293-A669	REV. B

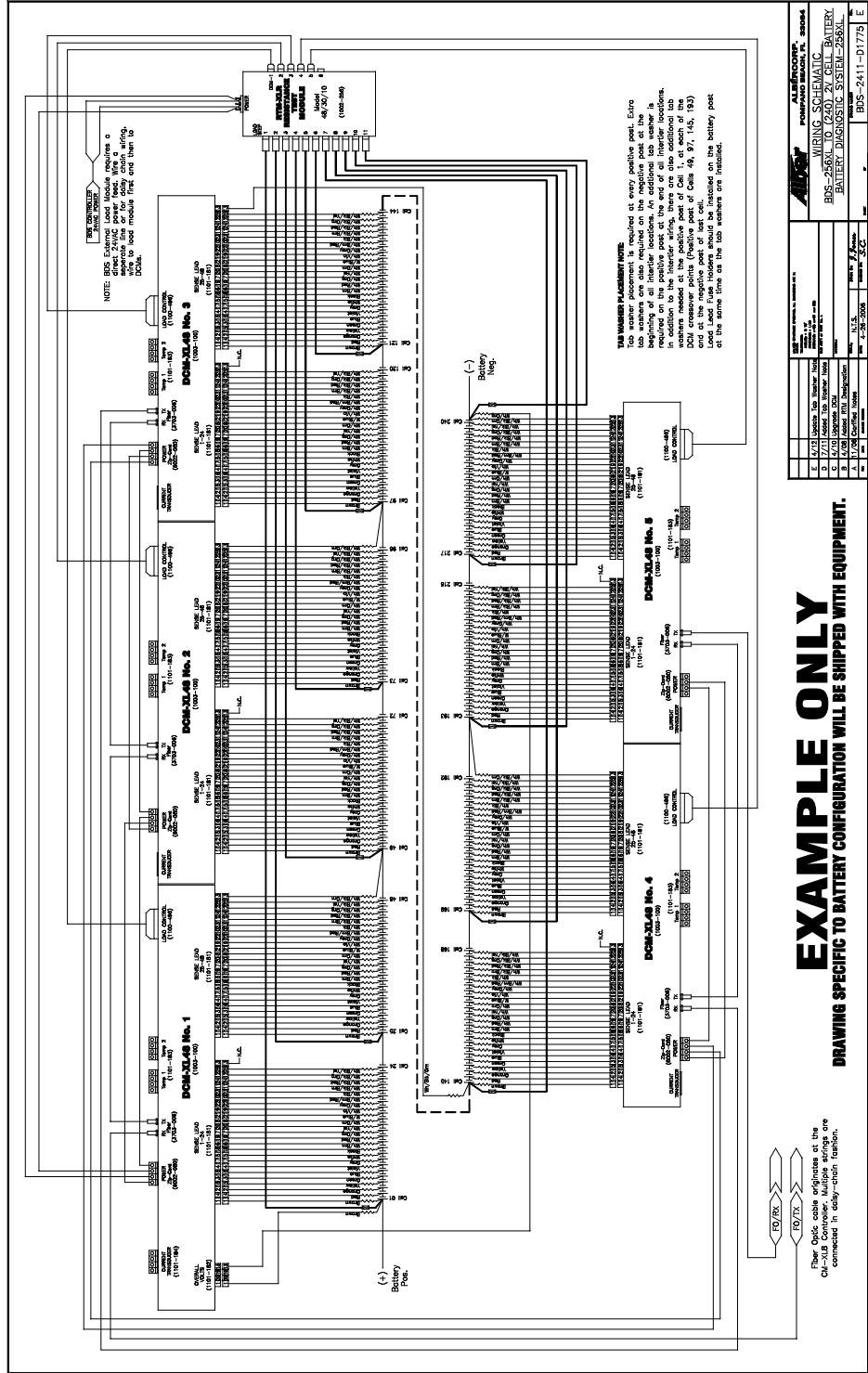

Figure 115. Wiring Schematic BDS-256 to (240) 2V Cell Battery

INDEX

- ¼ inch heat shrink tubing
 - pn 2880-004..... 18
- ¼ inch tab washer
 - pn 2120-028..... 16
- 10 gauge ⁵/₁₆ inch insulated ring term UL
 - pn 2800-109..... 14
- 12 gauge UL1015 red
 - pn 6002-037..... 16
- 30 amp cartridge fuse
 - pn 4302-030..... 16
- 30 amp connector block-UL
 - pn 2102-017..... 15
- 30 amp contact
 - pn 2102-018..... 16
- 7 ft telephone cable-UL
 - pn 6003-010..... 13
- AC power receptacle..... 38
- alarm contacts..... 63
- ambient temperature probe
 - pn 2900-029..... 18
- Andersen connector..... 15, 48, 49
- Andersen contact..... 49
- Andersen housing..... 15
- Anderson crimping tool
 - pn 5400-003..... 21
- ASCII..... 23
- BDS Flex resist w/butt splice
 - pn 1100-437BS..... 14
- BMDM software
 - pn 2027-001..... 23
- building mgt system..... 23, 24
- cabinet wiring..... 44, 62
- cable
 - cable tray..... 52
 - fiber optic length..... 42
 - fiber optic radius..... 44
 - maximum length..... 42
 - sense leads..... 52
 - test current..... 53
- CAUTION..... 46, 52, 54, 61, 63
- cell 1..... 44
- check connection/crimp..... 51
- configuration..... 45, 47
- connector interface
 - between harness and cell..... 16
- control cables..... 54
- crimp..... 48
- current transducer..... 54
- DB9..... 17
- discharge current sensor..... 54
- Drawing
 - BDS-1116-A479..... 13, 39
 - BDS-1132-A501..... 19, 39
 - BDS-123-A380..... 16, 39, 45
 - BDS-1251-A640..... 14, 21, 39
 - BDS-1277-B1202..... 39
 - BDS-1278-B1203..... 39, 61, 62
 - BDS-1280-B1205..... 39
 - BDS-136-A397..... 18, 19, 39
 - BDS-1470-A811..... 18, 19, 39, 56
 - BDS-163-A424..... 39
 - BDS-193-A453..... 14, 15, 16, 17, 39, 47
- earth ground..... 38
- electrolyte temperature probe
 - pn 2900-010..... 19
- FCCP..... 23
- female disconnect adapter
 - pn 2800-129..... 20
- fiber optic..... See also cable
- fiber optic amplifiers..... 42
- flameproof resistor..... 52, 53
- float current sensor..... 54
- form C alarm contacts..... 63
- fuse..... 16, 26, 35, 36, 37, 45, 47, 52, 53
- good connection/crimp..... 48
- grounding the equipment..... 38
- heat shrink tubing..... 51
- inline fuse holder assembly
 - pn 1100-433UL..... 17
- installation of system
 - with local computer..... 41, 62
 - with no local computer..... 61
- LAN connection..... 61, 63
- load lead wire connection..... 47
- load step fuse..... 16
- load step wire..... 16
- load too high..... 50

load too low	50	5400-006-Molex crimping tool	23
local computer	41, 62	5400-007-Panduit crimping tool	21
magnetic transducer.....	54	5400-008-Panduit crimping tool	21
mark cells	44	5610-016 CT.....	19
materials		5610-053 FCCP Kit	18
standard.....	12	6002-037-12 gauge UL1015 red wire.....	16
MODBUS.....	23, 24	6002-080-2 cond 16 Ga black zip cord	11
MODBUS maps.....	23	6003-006-Euro power cord.....	17
modem		6003-007-UK power cord	17
TELCO cord 26AWG	64, 65	6003-008-power cord	17
modem connection.....	61, 63	6003-010 TELCO/modem connection cable	13
modem TELCO connection cable	13	KIT-3703-015-fiber optic polishing kit	12
Multitel's FCCP users guide.....	56	polarity	50
network connection	61, 63	power cord Euro	
NOTE	24, 38, 42, 45, 63	pn 6003-006	17
OV sense leads.....	53	power cord UK	
Panduit cable tray	44	pn 6003-007	17
Panduit crimping tool		power cord US	
pn 5400-002.....	21	pn 6003-008	17
pn 5400-007.....	21	remote reset contact	63
pn 5400-008.....	21	repeater input/output.....	42
Part Number		resistor	52, 53
1100-433UL-inline fuse holder assembly ...	17	RJ-11 TELCO cord 26AWG.....	65
1100-437BS flex resist w/butt splice.....	14	RS-232 Local port	67
1101-167-xx-DCM Overall volts Cable	13	RS-232 serial cable	
1101-168 CT cable	19	2025-117	17
1101-171-xx-sense lead harness.....	10	RX	42
1101-172-xx-sense lead harness.....	10	sense lead harness	
1101-173-xx-sense lead harness.....	10	pn 1101-171-xx.....	10
1101-174-xx-sense lead harness.....	10	pn 1101-172-xx.....	10
1101-175-xx-sense lead harness.....	10	pn 1101-174-xx.....	10
1101-176-xx-sense lead harness.....	10	pn 1101-175-xx.....	10
1101-177-xx Float/CT cable	19	sense leads.....	52, 53
1101-496-xx-ELM/DCM Control.....	12	system diagram.....	41
2025-108-USB2 hi speed cable.....	14	technical library	23
2025-117-RS-232 serial cable	17	TELCO cord 26AWG	38, 64
2027-001-BMDM software	23	temperature sensor.....	54
2102-017-30 amp connector block	15	test current cable	53
2102-018- 30 amp contact.....	16	Thomas and Betts crimper.....	51
2102-028-¼ inch tab washer	16	transducer	54
2140-022-4 pos pluggable terminal	13	TX.....	42
2140-024-8 pos pluggable terminal	13	UPS	
2800-005-¼ inch heat shrink tubing	18	wiring	44, 62
2800-109-10 g ⁵ / ₁₆ inch insulated ring		USB cable	
terminal	14	pn 2025-108	14
2800-129-female disconnect adapter	20	USB2 hi speed cable	14
2900-010-electrolyte temperature probe ...	19	voltage sense lead connection	10
2900-049-ambient temperature probe	18	WARNING.....	20, 34, 35, 38, 41, 44, 45, 53
3703-006-fiber optic cable	12		
4302-030- 30 amp cartridge fuse.....	16		
5400-002-Panduit crimping tool.....	21		
5400-003-Andersen crimping tool.....	21		

website23

wire tray See cable tray